

# Integrated Camera Interface Specifications

## **Supplement for Web Control**

### Target Models

#### HE40 series

AW-HE70/AW-HE40/AW-HE65 (Ver1.32 and later)

AW-HE48/AW-HE58

AW-HE35/AW-HE38

AW-HN38/AW-HN40/AW-HN65/AW-HN70

#### UE70 series

AW-UE70 (Ver1.04 and later)

AW-UN70

AW-UE65/AW-UE63

#### HE42 series

AW-HE42/AW-HE75/AW-HE68

Second Edition

Panasonic Corporation

## Change History

December 21, 2015	Initial Release
September 17, 2019	Second Edition Release (Correction of mistakes, addition of models, addition of functions)

# Table of Contents

Change History.....	1
1. Introduction.....	4
2. CGI List for Video Transmission .....	5
2.1. Transmission User Management.....	5
2.2. Device Information Acquisition .....	8
2.3. Camera-specific Information (Capability) Acquisition.....	11
2.4. JPEG-based Image Transmission .....	15
2.5. Image Transmission Sequence based on MJPEG .....	19
2.6. Image Transmission Sequence based on JPEG Image 1 shot.....	20
2.7. H264/AUDIO-based Image Transmission.....	21
2.8. Unicast Image Transmission Sequence based on H264 .....	23
3. CGI List for Camera Control .....	24
3.1. Pan/Tilt/Zoom.....	24
4. CGI List for Various Settings.....	26
4.1. Basic Settings .....	26
4.2 Clock Settings.....	27
4.3. Video over IP Settings.....	28
4.4. Audio Settings.....	38
4.5. Multi-screen Settings.....	39
4.6. Priority Stream Settings.....	40
4.7. Network Settings.....	41
4.8. UPnP Settings.....	44
4.9. Restarting.....	44
5. CGI List for Acquisition of Different Types of Information.....	45
5.1. Basic Settings Information Acquisition.....	45
5.2. NTP Settings Information Acquisition .....	45
5.3. Clock Settings Information Acquisition .....	46
5.4. Priority Mode Acquisition.....	46
5.5. VideoOverIP Screen Information Acquisition.....	47
5.6. Audio Settings Information Acquisition .....	49
5.7. Multi-screen Settings Information Acquisition .....	49
5.8. Host Authentication Settings Information Acquisition.....	50
5.9. Priority Stream Settings Information Acquisition .....	50
5.10. Network Settings Information Acquisition .....	51
5.11. UPnP Settings Information Acquisition .....	51
5.12. System Log Information Acquisition .....	52
5.13. Camera Status Acquisition .....	53
5.14. UPnP Execution Results Acquisition .....	54
5.15. Preset Position Information Acquisition .....	54
5.16. Other Setting Values Acquisition .....	55
6. CGI List for HTTPS Control .....	60
6.1. Setting Information and Acquiring Certification .....	60
6.2. Information Acquisition .....	61
7. CGI List for FTP Control .....	62
7.1. FTP Server Settings.....	62
7.2. FTP Server Transfer Instruction .....	63

7.3. FTP Server Information Acquisition .....	64
7.4. FTP Server Progress Confirmation.....	64
7.5. FTP Control Sequence.....	65
7.6. About Folder Settings at the FTP Server Side.....	66
8. CGI List for Recording/Playback Control on SD Card .....	67
8.1. Video Recording Mode Settings .....	67
8.2. Video Recording Mode Acquisition.....	68
8.3. Video Recording Start/End Control .....	68
8.4. SD Card Format (Initialization) Control.....	69
8.5. SD Card Format (Initialization) Progress Confirmation .....	69
8.6. MP4 File List Search .....	70
8.7. MP4 File Playback Control .....	71
8.8. MP4 File Playback Sequence.....	72
8.9. MP4 File Deletion.....	73
8.10. Acquiring Information of MP4 File being Played Back .....	73
8.11. MP4 File Download Control.....	74
8.12. MP4 File Download Sequence .....	74
8.13. Still picture image save .....	75
8.14. Still picture image load / delete / find.....	76
9. Acquiring the List of Setting Values .....	77
10. About Control Based on RTSP .....	86
10.1. About the URLs for an RTSP Request .....	86
10.2. About the rtsp Methods .....	87
11. About Acquisition of Stream from RTSP .....	88
11.1. UDP Unicast .....	88
11.2. UDP Multicast .....	92
11.3. TCP Unicast.....	96
11.4 About the rtpmap Attribute .....	100
12. About Control Based on RTCP .....	101
13. About RTP/Data Format .....	102
13.1. RTP Header Format.....	102
13.2. Relationship with H.264/ES Data .....	103
13.3. H.264 Syntax .....	104
13.4. Audio Data Format .....	104

# 1. Introduction

This manual describes the specifications for video transmission and network application operation when a remote camera is operated via the network. For details on the general camera operations of the remote camera, see the separate volume "HD Integrated Camera Interface Specifications".

Panasonic shall not take any responsibility of damages caused as a result of the use of this information. This information may be changed without prior notice due to upgrade of product version in future. The usage examples are only reference examples for this series. Support cannot be offered for each program. Moreover, some information of the communication between the camera and browser is not disclosed.

## **About the access levels**

In this manual, "Live" and "Admin" are defined as the access levels. The necessity of the ID/password during CGI execution is changed from the User auth. menu of the remote camera.

When User auth. is OFF (factory settings):

- |   |   |
|---|---|
| Live (Video acquisition and camera control) | ... Authentication not necessary                          |
| Admin (All SETUP controls)                  | ... ID/password for Administrator authority are necessary |

When User auth. is ON:

- |   |  |
|---|--|
| Live (Video acquisition and camera control) | ... ID/password for camera control<br>or Administrator authority are necessary |
| Admin (All SETUP controls)                  | ... ID/password for Administrator authority are necessary                      |

## **About the priority mode**

The type of CGI that can be executed and the range of parameter values differ depending on the priority mode of the remote camera.

For details, see the instruction manual.

Example) When the priority mode (/cgi-bin/set\_priority\_mode, /cgi-bin/get\_priority\_mode) is SD priority  
=> Control cannot be performed for H.264 (1) to (4).

## **About the types and range of parameter values**

The type of CGI that can be executed and the range of parameter values differ depending on the model.

For details, see the instruction manual.

Example) Selection of 3840 x 2160  
=> Enabled only in UE70 series.

## 2. CGI List for Video Transmission

### 2.1. Transmission User Management

Method : GET

Access level : Live

CGI item name	URL	Parameter name	Parameter value	Description
Transmission user management	/cgi-bin/getuid	FILE	2	2 (Fixed)
		vcodec	jpeg h264 h264_2  h264_3  h264_4	jpeg: During JPEG transmission h264: During H.264(1) transmission h264_2: During H.264(2) transmission h264_3: During H.264(3) transmission h264_4: During H.264(4) transmission
		reply	browser info	Command response format specification (can be omitted) browser: for the camera browser info: for the application

Usage example) Acquisition of user ID (during H264(1) transmission)

<http://192.168.0.10/cgi-bin/getuid?FILE=2&vcodec=h264>

The response data is as shown below.

```
UID=< User ID >[CR][LF]
ImageFormat=< Video format >[CR][LF]
ImageCaptureMode=< Image Capture Mode >[CR][LF]
ratio=< Aspect ratio >[CR][LF]
Maxfps=< Max fps >[CR][LF]
StreamMode=< Stream mode >[CR][LF]
iBitrate=< H.264 bitrate >[CR][LF]
iResolution=< H.264 resolution >[CR][LF]
iQuality=<H.264 quality >[CR][LF]
sDelivery=< setting >[CR][LF]
iUniPort=< Unicast port number >[CR][LF]
iMultiAdd1=< 1st octet of multicast address >[CR][LF]
iMultiAdd2=< 2nd octet of multicast address >[CR][LF]
iMultiAdd3=< 3rd octet of multicast address >[CR][LF]
iMultiAdd4=< 4th octet of multicast address >[CR][LF]
iMultiAdd=< multicast address >[CR][LF]
iMultiPort=< Multicast port number >[CR][LF]
aEnable=< Audio mode>[CR][LF]
aEnc=< Audio enc >[CR][LF]
```

aBitrate=< Audio bit rate >[CR][LF]  
aBitrate2=< Audio bit rate >[CR][LF]  
aInterval=< Audio input interval >[CR][LF]  
aInPort=< Audio unicast port number >[CR][LF]  
aOutInterval=< Audio output interval >[CR][LF]  
aOutPort=< Audio output port >[CR][LF]  
aOutStatus=< Audio output status >[CR][LF]  
aOutUID=< Audio output UID >[CR][LF]  
ePort=< Event notification port number >[CR][LF]  
sAlarm=< Alarm status >[CR][LF]  
SDrec=< Recording status >[CR][LF]  
SDrec2=< Recording status >[CR][LF]  
sAUX=< Aux status >[CR][LF]  
iHttpPort=< HTTP port number >[CR][LF]  
iMultiAuto\_h264=< Multicast auto H.264(1) >[CR][LF]  
iMultiAuto\_h264\_2=< Multicast auto H.264(2) >[CR][LF]  
iMultiAuto\_h264\_3=< Multicast auto H.264(3) >[CR][LF]  
iMultiAuto\_h264\_4=< Multicast auto H.264(4) >[CR][LF]  
sRtspMode\_h264=< Control mode H.264(1) >[CR][LF]  
sRtspMode\_h264\_2=< Control mode H.264(2) >[CR][LF]  
sRtspMode\_h264\_3=< Control mode H.264(3) >[CR][LF]  
sRtspMode\_h264\_4=< Control mode H.264(4) >[CR][LF]

The description of the response data is as shown below.

Item	Value of response	Description
UID	Numeric value	User ID
ImageFormat	jpeg, h264, h264_X	During JPEG transmission During H.264(1) transmission During H.264(X) transmission
ImageCaptureMode	2m	Fixed value
ratio	16_9	Fixed value
Maxfps	30, 60	Max. frame rate
StreamMode	1	Fixed value
iBitrate	Numeric value	Bit rate setting of H.264
iResolution	320, 640, 1280, 1920, 3840 (*1)	Horizontal resolution setting of H.264 (*1): Only for UE70 series
iQuality	fine, low	Image quality setting of H.264
sDelivery	uni, multi, uni_manual	uni: unicast (auto) multi: multicast uni_manual: unicast (manual)
iUniPort	1024 to 50000	Unicast port number (image)
iMultiAdd1	224 to 239	First octet of multicast address
iMultiAdd2	0 to 255	Second octet of multicast address
iMultiAdd3	0 to 255	Third octet of multicast address
iMultiAdd4	0 to 255	Fourth octet of multicast address

Item	Value of response	Description
iMultiAdd	(IP address)	H.264 multicast address
iMultiPort	Numeric value	Multicast port number
aEnable	off, in	off: Audio OFF in: Audio ON (reception)
aEnc	2	Fixed value (2: AAC)
aBitrate	128,96, 64	Bit rate setting of audio
aBitrate2	64	Fixed value
aInterval	20	Fixed value
aInPort	1024 to 50000	Unicast port number (audio)
aOutInterval	640	Fixed value
aOutPort	34004	Fixed value
aOutStatus	off	Fixed value
aOutUID	0	Fixed value
ePort	31004	Fixed value
sAlarm	off	Fixed value
SDrec	disable	Fixed value
SDrec2	disable	Fixed value
sAUX	disable	Fixed value
iHttpPort	Numeric value	HTTP port number
iMultiAuto_h264	0	Fixed value
iMultiAuto_h264_2	0	Fixed value
iMultiAuto_h264_3	0	Fixed value
iMultiAuto_h264_4	0	Fixed value
sRtspMode_h264	0	Fixed value
sRtspMode_h264_2	0	Fixed value
sRtspMode_h264_3	0	Fixed value
sRtspMode_h264_4	0	Fixed value



## 2.2. Device Information Acquisition

Method : GET

Access level : Live

CGI item name	URL	Parameter name	Parameter value	Description
Device information acquisition	/cgi-bin/getinfo	FILE	1	1 (Fixed)

Usage example) Acquisition of user ID (during H264(1) transmission)

http://192.168.0.10/cgi-bin/getinfo?FILE=1

The response data is as shown below.

```
MAC=< Mac address >[CR][LF]
SERIAL=< Serial number >[CR][LF]
VERSION=< Firmware version >[CR][LF]
NAME=< Model name >[CR][LF]
SDrec=< Recording status >[CR][LF]
SDrec2=< Recording status >[CR][LF]
sAlarm=< Alarm status >[CR][LF]
sAUX=< Aux status >[CR][LF]
ePort=< Event notification port number >[CR][LF]
aEnable=< Audio mode>[CR][LF]
aEnc=< Audio enc >[CR][LF]
aBitrate=< Audio bit rate >[CR][LF]
aBitrate2=< Audio bit rate >[CR][LF]
aInterval=< Audio input interval >[CR][LF]
aOutInterval=< Audio output interval >[CR][LF]
aOutPort=< Audio output port >[CR][LF]
aOutStatus=< Audio output status >[CR][LF]
aOutUID=< Audio output UID >[CR][LF]
alnPort_h264=< Audio with H.264 1st stream unicast port number >[CR][LF]
alnPort_h264_2=< Audio with H.264 2nd stream unicast port number >[CR][LF]
alnPort_h264_3=< Audio with H.264 3rd stream unicast port number >[CR][LF]
alnPort_h264_4=< Audio with H.264 4th stream unicast port number >[CR][LF]
sRtspMode_h264=< Control mode H.264(1) >[CR][LF]
sRtspMode_h264_2=< Control mode H.264(2) >[CR][LF]
sRtspMode_h264_3=< Control mode H.264(3) >[CR][LF]
sRtspMode_h264_4=< Control mode H.264(4) >[CR][LF]
ImageCaptureMode=< limage Capture Mode >[CR][LF]
ratio=< Aspect ratio >[CR][LF]
Maxfps=< Max fps >[CR][LF]
StreamMode=< Stream mode >[CR][LF]
iTransmit_h264=< H.264 1st stream ON/OFF setting >
sDelivery_h264=< H.264 1st stream setting >[CR][LF]
iBitrate_h264=< H.264 1st stream bit rate >[CR][LF]
iResolution_h264=< H.264 1st stream resolution >[CR][LF]
```

iQuality\_h264=< H.264 1st stream quality >[CR][LF]  
 iMultiAuto\_h264=< Multicast auto H.264(1) >[CR][LF]  
 iTransmit\_h264\_2=< H.264 2nd stream ON/OFF setting >  
 sDelivery\_h264\_2=< H.264 2nd stream setting >[CR][LF]  
 iBitrate\_h264\_2=< H.264 2nd stream bit rate >[CR][LF]  
 iResolution\_h264\_2=< H.264 2nd stream resolution >[CR][LF]  
 iQuality\_h264\_2=< H.264 2nd stream quality >[CR][LF]  
 iMultiAuto\_h264\_2=< Multicast auto H.264(2) >[CR][LF]  
 iTransmit\_h264\_3=< H.264 3rd stream ON/OFF setting >  
 sDelivery\_h264\_3=< H.264 3rd stream setting >[CR][LF]  
 iBitrate\_h264\_3=< H.264 3rd stream bit rate >[CR][LF]  
 iResolution\_h264\_3=< H.264 3rd stream resolution >[CR][LF]  
 iQuality\_h264\_3=< H.264 3rd stream quality >[CR][LF]  
 iMultiAuto\_h264\_3=< Multicast auto H.264(3) >[CR][LF]  
 iTransmit\_h264\_4=< H.264 4th stream ON/OFF setting >  
 sDelivery\_h264\_4=< H.264 4th stream setting >[CR][LF]  
 iBitrate\_h264\_4=< H.264 4th stream bit rate >[CR][LF]  
 iResolution\_h264\_4=< H.264 4th stream resolution >[CR][LF]  
 iQuality\_h264\_4=< H.264 4th stream quality >[CR][LF]  
 iMultiAuto\_h264\_4=< Multicast auto H.264(4) >[CR][LF]

The description of the response data is as shown below.

Item	Value of response	Description
MAC	XX-XX-XX-XX-XX-XX	MAC address
SERIAL	XXXXXXXXXX	Product serial number
VERSION		Software version
NAME	AW-XXXX	Product number
SDrec	disable	Fixed value
SDrec2	disable	Fixed value
sAlarm	off	Fixed value
sAUX	off	Fixed value
ePort	31004	Fixed value
aEnable	off, in	off: Audio OFF in: Audio ON (reception)
aEnc	2	Fixed value (2: AAC)
aBitrate	128,96,64	Bit rate setting of audio
aBitrate2	64	Fixed value
aInterval	20	Fixed value
aOutInterval	640	Fixed value
aOutPort	34004	Fixed value
aOutStatus	off	Fixed value
aOutUID	0	Fixed value
alnPort_h264	1024 to 50000	H.264(1) Audio reception port number
alnPort_h264_2	1024 to 50000	H.264(2) Audio reception port number
alnPort_h264_3	1024 to 50000	H.264(3) Audio reception port number

alnPort_h264_4	1024 to 50000	H.264(4) Audio reception port number
sRtspMode_h264	0	Fixed value
sRtspMode_h264_2	0	Fixed value
sRtspMode_h264_3	0	Fixed value
sRtspMode_h264_4	0	Fixed value
ImageCaptureMode	2m	Fixed value
ratio	16_9	Fixed value
Maxfps	30, 60	Max. frame rate
StreamMode	1	Fixed value
iTransmit_h264	1	Fixed value
sDelivery_h264	uni, multi, uni_manual	uni: Unicast (auto) multi: Multicast uni_manual Unicast (manual)
iBitrate_h264	Numeric value	Bit rate setting of H.264(1)
iResolution_h264	320, 640, 1280, 1920, 3840 (*1)	Horizontal resolution setting of H.264(1) (*1): Only for UE70 series
iQuality_h264	fine, low	Image quality setting of H.264(1)
iMultiAuto_h264	0	Fixed value
iTransmit_h264_2	see.H.264(1)	see.H.264(1)
sDelivery_h264_2		
iBitrate_h264_2		
iResolution_h264_2		
iQuality_h264_2		
iMultiAuto_h264_2		
iTransmit_h264_3	see.H.264(1)	see.H.264(1)
sDelivery_h264_3		
iBitrate_h264_3		
iResolution_h264_3		
iQuality_h264_3		
iMultiAuto_h264_3		
iTransmit_h264_4	see.H.264(1)	see.H.264(1)
sDelivery_h264_4		
iBitrate_h264_4		
iResolution_h264_4		
iQuality_h264_4		
iMultiAuto_h264_4		

## 2.3. Camera-specific Information (Capability) Acquisition

Method : POST/ GET

Access level : Live

CGI item name	URL	Parameter name	Parameter value	Description
Camera-specific information (Capability) acquisition	/cgi-bin/get_capability	-	-	Explained under the next item

Usage example) Camera-specific information (Capability) acquisition

[http://192.168.0.10/cgi-bin/get\\_capability](http://192.168.0.10/cgi-bin/get_capability)

The description of the response data is as shown below.

Group name	Parameter name	Parameter value	Description
common	capability_version	1.00	Version of the capability format
	category	camera	Category
video_server.basic	type	dome	Product shape
	fisheye	no	Fisheye camera
video_server.basic.analogue_input	supported	ntsc,pal	Supported video signals of the analog camera (encoder)
video_server.cam_ctrl.ptz	supported	yes	Availability of PTZ function
	zoom	30	Zoom magnification
	el_zoom	40	Electronic zoom magnification
	command	camctrl direct_16 direct_256d direct_256r	Supported PTZ commands
video_server.cam_ctrl.ptz.pan_range	type	limited	Pan operation limited: Endless operation not possible
	abs_value	-	Not supported
video_server.cam_ctrl.ptz.tilt_range	value	-	Not supported
video_server.cam_ctrl.brightness	supported	yes	Support for brightness control command
	command	camctrl_bright camctrl_IRIS	Types of supported commands
video_server.cam_ctrl.abf	supported	no	Support for ABF command
video_server.cam_ctrl.focus	supported	yes	Support for focus command
video_server.cam_ctrl.auto_focus	supported	yes	Support for auto-focus command
video_server.cam_ctrl.bw	supported	no	Support for black and white selection command
video_server.cam_ctrl.auto_mode	supported	no	Support for auto mode
video_server.cam_ctrl.preset	supported	yes	Support for preset movement command
	number	100	Number of preset positions



Group name	Parameter name	Parameter value	Description
	framerate	1 to 30	Frame rates supported in the JPEG stream Rounded down to the nearest whole number NTSC: 1 to 30 PAL: 1 to 25
video_server.image.mjpeg.max_framerate	2m_r16_9	30	Max. frame rate of JPEG stream
video_server.image.mjpeg.resolution_each_mode	2m_r16_9	1920x1080, 1280x720, 640x360, 320x180	Setting-enabled JPEG resolution
video_server.image.mjpeg.resolution_each_mode_all	2m_r16_9	1920x1080, 1280x720, 640x360, 320x180	Setting-enabled JPEG resolution
video_server.image.h264	resolution	3840x2160(*1), 1920x1080, 1280x720, 640x360, 320x180	Resolution parameters supported in H.264(1) (*1): Only for UE70 series
	stream_mode	bitrate, framerate, best_effort	Transmission modes supported in H.264(1)
	quality	fine, normal	Image quality parameters supported in H.264(1)
	bandwidth	512,768,1024,1536,2048,3072,4096, 6144,8192,10240, 12288,14336, 16384,20480, 24576, 32768(*1), 40960(*1), 51200(*1)	Bit rate parameters supported in H.264(1) (*1): Only for UE70 series
	framerate	5,15(12.5),30(25), 60(50)	Frame rate parameters supported in H.264(1) * The values within () are for the case when the system frequency is 50 Hz
video_server.image.h264.resolution_each_mode	2m_r16_9	3840x2160(*1), 1920x1080, 1280x720, 640x360, 320x180	Supported H.264(1) resolutions (*1): Only for UE70 series
video_server.image.h264.max_framerate	2m_r16_9	60	Supported max. H.264(1) frame rate
video_server.image.h264-2	Same as H264-1		
video_server.image.h264-2.resolution_each_mode			
video_server.image.h264-2.max_framerate			

Group name	Parameter name	Parameter value	Description
video_server.image.h264-3			
video_server.image.h264-3.resolution_each_mode			
video_server.image.h264-3.max_framerate			
video_server.image.h264-4			
video_server.image.h264-4.resolution_each_mode			
video_server.image.h264-4.max_framerate			
video_server.audio	transmission	input	Audio transmission setting mode
video_server.audio.audio_input	number	1	Audio microphone input number
	encode_type	aac-1c_64K aac-1c_96K aac-1c_128K	Supported audio input encoding type
video_server.sdcard	supported	yes	Support for SD memory card function
	media_type	sd, sdhc, sdxc	Supported SD memory card type
video_server.sdcard.replay_mp4	supported	no	Support for the function for playing back MP4 files saved in the SD memory card inside the camera
video_server.network	nw_bandwidth	1024,2048,4096,8192,16384,32768	Parameters supported in the overall transmission volume setting
video_server.network.ipv6	supported	yes	IPv6 support status
video_server.network.https	supported	yes	HTTPS (SSL) support status
video_server.vmd	supported	no	VMD support status

## 2.4. JPEG-based Image Transmission

Method : GET

Access level : Live

CGI item name	URL	Parameter name	Parameter value	Description
JPEG image transmission (MJPEG)	/cgi-bin/jpeg	connect	Start stop	start: Starts JPEG image transmission stop: Stops JPEG image transmission
		framerate	1 5 15(12.5) 30(25)	1 fps 5 fps 15 (12.5) fps 30 (25) fps The values within () are for the case when the system frequency is 50 Hz
		resolution	320 640 1280 1920	320: 320 x 180 640: 640 x 360 1280: 1280 x 720 1920: 1920 x 1080
		UID	Numeric value	User ID * UID acquired by /cgi-bin/getuid
JPEG image transmission (MJPEG)	/cgi-bin/mjpeg	resolution	320 640 1280 1920	320: 320 x 180 640: 640 x 360 1280: 1280 x 720 1920: 1920 x 1080
		framerate	1 5 15(12.5) 30(25)	1 fps 5 fps 15 (12.5) fps 30 (25) fps The values within () are for the case when the system frequency is 50 Hz
JPEG image 1 shot request	/cgi-bin/view.cgi	action	Snapshot start stop	snapshot: Acquires one JPEG image start: Starts JPEG transmission stop: Stops JPEG transmission
		n	Numeric value	Dummy for disabling cache
Resolution setting for view.cgi	/cgi-bin/aw_ptz	cmd	%23RZL1&res=1 %23RZL0&res=1	%23RZL1&res = 1: 320 x 180 setting %23RZL0&res = 1: 640 x 360 setting
JPEG image 1 shot request	/cgi-bin/camera	resolution	320 640 1280 1920	320: 320 x 180 640: 640 x 360 1280: 1280 x 720 1920: 1920 x 1080
		page	Numeric value	Dummy for disabling cache
Playback data transmission	/cgi-bin/view_playback.cgi	-	-	Acquires one playback image (H.264/JPEG converted)



## [Notes]

In a remote camera, various techniques are provided for acquisition of a JPEG video. Use the technique suitable to your purpose.

### MJPEG

By continuously displaying the videos that arrive, a movie display can be realized.

The frame rate is decided based on the arguments.

Depending on the software and hardware at the receiving side, some frame rates may not be supported.

### JPEG image 1 shot

By repeating the processes of acquisition, display, and standby for a single JPEG image, a movie display can be realized.

The frame rate is decided according to the standby time in the software and hardware at the receiving side.

The characteristics of each CGI of MJPEG are as described below.

#### /cgi-bin/jpeg

When CGI is called once, the MJPEG stream is transmitted continuously.

Before calling, the acquisition of UID with /cgi-bin/getuid is necessary.

In Internet Explorer, the plug-in software is used when calling JPEG(1) to (3).

Specific usage examples and sequences are described in the next chapter.

#### /cgi-bin/mjpeg

When CGI is called once, the MJPEG stream is transmitted continuously.

Before calling, the acquisition of UID with /cgi-bin/getuid is not necessary.

It is used when calling JPEG from some mobile terminals.

In Safari, movie display is possible by entering only this CGI in the URL field of the browser. Not supported by Internet Explorer.

Usage example) When acquiring a 320 x 180 video in 30 fps in the MJPEG format:

<http://192.168.0.10/cgi-bin/mjpeg?resolution=320&framerate=30>

Usage example) When acquiring a 640 x 360 video in 15 fps in the MJPEG format:

<http://192.168.0.10/cgi-bin/mjpeg?resolution=640&framerate=15>

Usage example) When acquiring a video of approx. 5 fps in the MJPEG format (parameter omitted):

<http://192.168.0.10/cgi-bin/mjpeg>

The characteristics of each CGI of JPEG image 1 shot are as described below.

#### /cgi-bin/view.cgi

When CGI is called once, only one JPEG image is transmitted.

Before calling, the acquisition of UID with /cgi-bin/getuid is not necessary.

The resolution can be set with the /cgi-bin/aw\_ptz?cmd=%23RZLx&res=1 command.

Not supported by other than 640 x 360 / 320 x 180.

Used when calling a JPEG image without the use of plug-in software in Internet Explorer.

Usage example) When acquiring a 320 x 180 video through a JPEG image 1 shot request:

[http://192.168.0.10/cgi-bin/aw\\_ptz?cmd=%23RZL1&res=1](http://192.168.0.10/cgi-bin/aw_ptz?cmd=%23RZL1&res=1)

<http://192.168.0.10/cgi-bin/view.cgi?action=start>

<http://192.168.0.10/cgi-bin/view.cgi?action=snapshot&n=3333>

<Appropriate standby time>

<http://192.168.0.10/cgi-bin/view.cgi?action=snapshot&n=3334>

<Appropriate standby time>

<http://192.168.0.10/cgi-bin/view.cgi?action=snapshot&n=3335>

While the "start" command is mandatory after turning the power supply ON, the "stop" command is not mandatory. The "start" command may be issued any number of times without any problem.

#### /cgi-bin/camera

When CGI is called once, only one JPEG image is transmitted.

Before calling, the acquisition of UID with /cgi-bin/getuid is not necessary.

In Internet Explorer, the plug-in software is used when acquiring a screen shot.

The notes common for each CGI are as described below.

When a video is acquired simultaneously by several PCs and receivers, the best effort judgment is performed at the camera side. Therefore, the expected frame rate display may not be achieved.

When the WEB menu/Video over IP/JPEG/JPEG transmission are OFF, the response may be in the form of a pitch black JPEG image.

As for the resolution and frame rate, the content registered in the WEB menu/Video over IP/JPEG is given priority.

Therefore, even if the resolution is specified in the arguments, the response may be issued with an unexpected resolution and frame rate.

Example) If JPEG(1) = 640 x 360/30 fps, JPEG(2) = 1280 x 720/5 fps, JPEG(3) = 320 x 180/15 fps,

/cgi-bin/mjpeg?resolution=320&framerate=15

=> As instructed, the response is in the form of content of the 320 x 180 JPEG(3).

/cgi-bin/mjpeg?resolution=640&framerate=15

=> As instructed, the response is issued by subtracting the frame rate from the content of the 640 x 360 JPEG(1)

/cgi-bin/mjpeg?resolution=1280&framerate=15

=> The response is issued with a resolution of 1280 x 720, but the frame rate is 5 fps, which is the upper limit of JPEG(2).

/cgi-bin/mjpeg?resolution=320&framerate=1920

=> Because no content is registered in JPEG(1) to (3), the response is issued with the resolution of JPEG(1) and a frame rate of 5 fps.

/cgi-bin/mjpeg

=> Because there are no parameters, the response is issued with the resolution of JPEG(1) and a frame rate of 5 fps.

Note that if you use /cgi-bin/aw\_ptz?cmd=%23RZLx&res=1, the resolution of JPEG(1) changes.

## 2.5. Image Transmission Sequence based on MJPEG

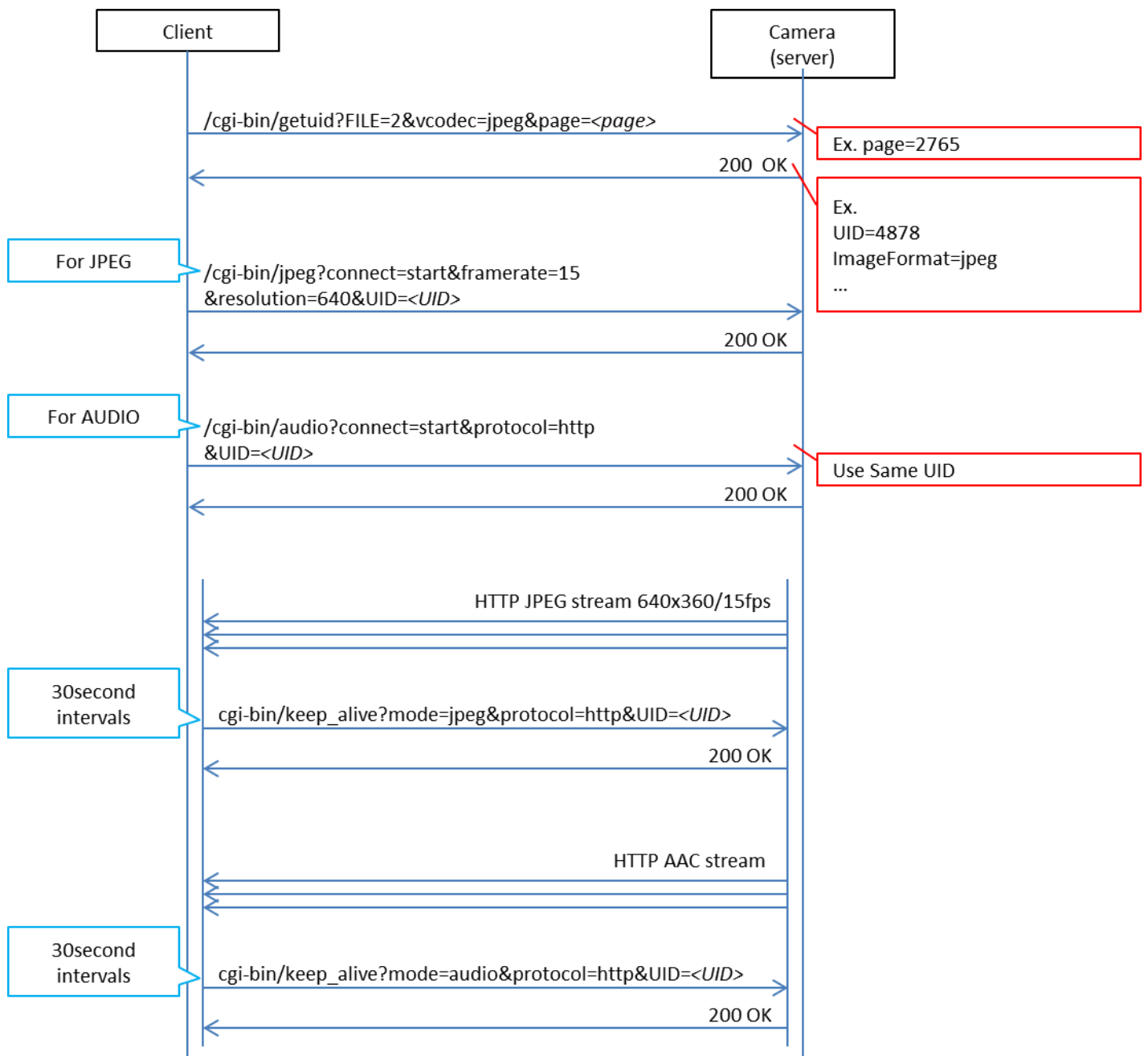

MJPEG Sequence

## 2.6. Image Transmission Sequence based on JPEG Image 1 shot

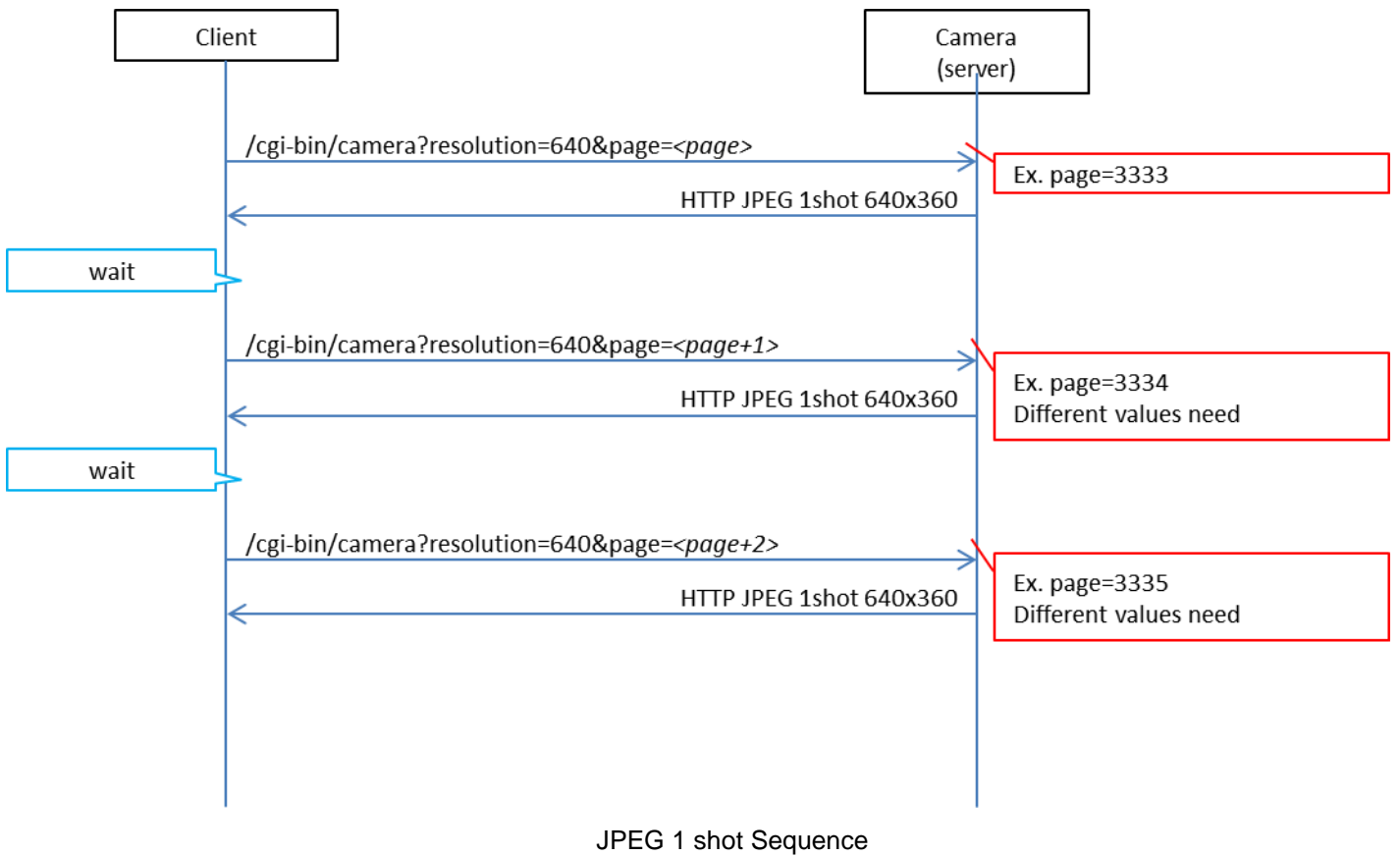

## 2.7. H264/AUDIO-based Image Transmission

Method : GET

Access level : Live

CGI item name	URL	Parameter name	Parameter value	Description
H.264 image transmission	/cgi-bin/h264	my_port	Numeric value	Reception port number of H.264 * This parameter cannot be omitted if unicast is set.
		connect	start stop	start: Starts H.264 transmission stop: Stops H.264 transmission
		protocol	rtp	rtp: RTP format (can be omitted)
		UID	Numeric value	User ID * UID acquired by /cgi-bin/getuid
		stream	1 2 3 4	1: Stream 1 2: Stream 2 3: Stream 3 4: Stream 4
Audio transmission	/cgi-bin/audio	connect	start stop	start: Starts audio transmission stop: Stops audio transmission
		protocol	rtp http	rtp: RTP transmission http: HTTP transmission
		my_port	Numeric value	Reception port number of audio data *Only when protocol = rtp Can be omitted during HTTP transmission
		UID	Numeric value	User ID * UID acquired by /cgi-bin/getuid
		mode	in	in: Fixed
Volume control	/cgi-bin/audio_vol	in_vol	low mid high line_low line_mid line_high	low: Low mid: Middle high: High line_low: Line Low line_mid: Line Middle line_high: Line High
Keep alive	/cgi-bin/keep_alive	mode	h.264 h.264_2 h.264_3 h.264_4 jpeg audio	h.264: H.264 keep alive h.264_2: H.264(2) keep alive h.264_3: H.264(3) keep alive h.264_4: H.264(4) keep alive jpeg: JPEG keep alive audio: Audio keep alive
		protocol	rtp http	rtp: RTP transmission http: HTTP transmission
		UID	Numeric value	User ID * UID acquired by /cgi-bin/getuid

CGI item name	URL	Parameter name	Parameter value	Description
		stream	1 2 3 4	1: Stream 1 2: Stream 2 3: Stream 3 4: Stream 4 * Can be omitted

Usage example) H264(1) image transmission start (when the port number is "40000" and User ID is "263")  
[http://192.168.0.10/cgi-bin/h264?my\\_port=40000&connect=start&protocol=rtp&UID=263&stream=1](http://192.168.0.10/cgi-bin/h264?my_port=40000&connect=start&protocol=rtp&UID=263&stream=1)

Usage example) Audio transmission start  
[http://192.168.0.10/cgi-bin/audio?my\\_port=38004&connect=start&protocol=rtp&UID=263&mode=in](http://192.168.0.10/cgi-bin/audio?my_port=38004&connect=start&protocol=rtp&UID=263&mode=in)

Usage example) Audio volume setting  
[http://192.168.0.10/cgi-bin/audio\\_vol?in\\_vol=low](http://192.168.0.10/cgi-bin/audio_vol?in_vol=low)

Usage example) Keep alive (JPEG)  
[http://192.168.0.10/cgi-bin/keep\\_alive?mode=jpeg&protocol=http&UID=263](http://192.168.0.10/cgi-bin/keep_alive?mode=jpeg&protocol=http&UID=263)

## 2.8. Unicast Image Transmission Sequence based on H264

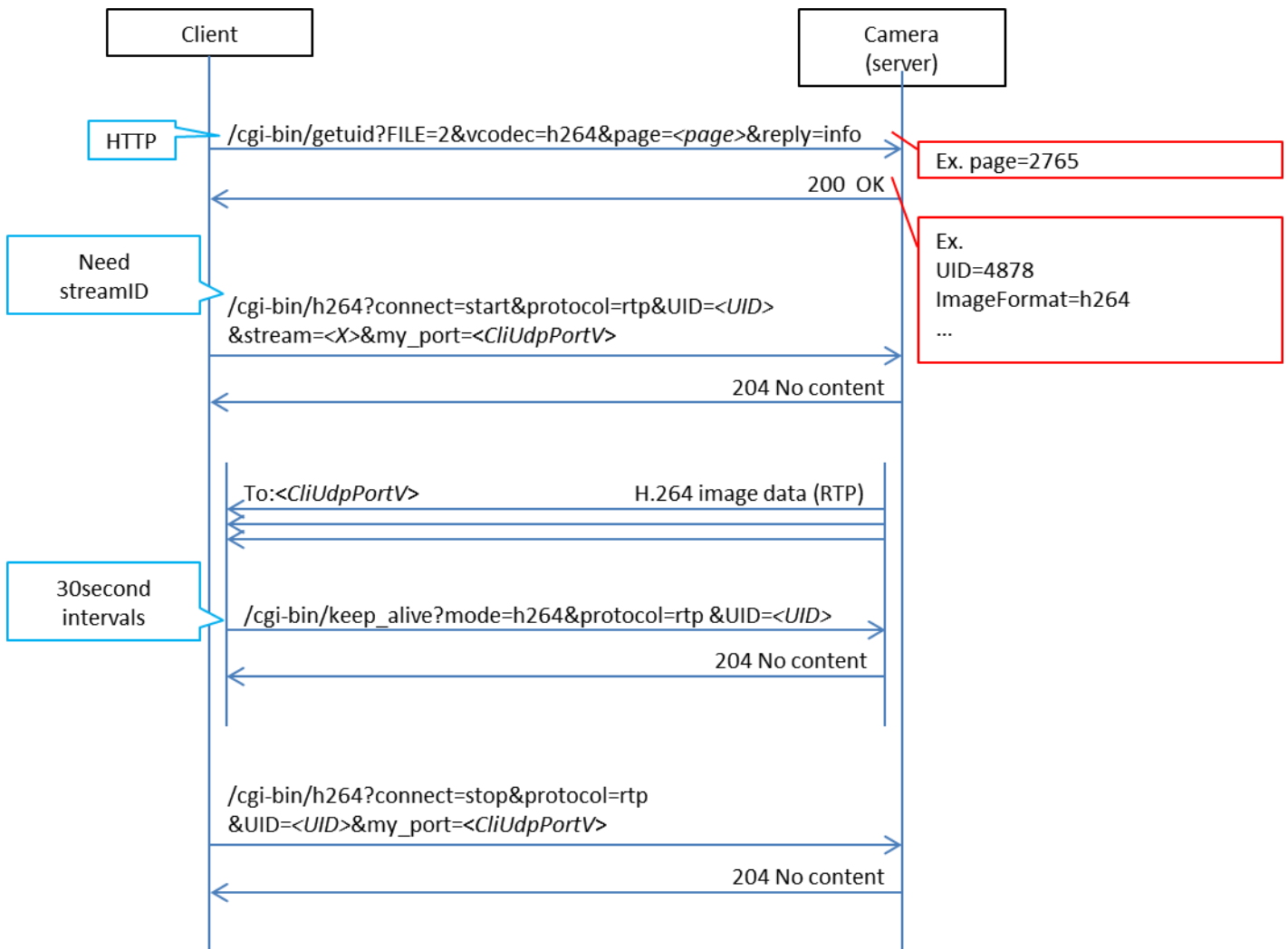

H264 Sequence



### 3. CGI List for Camera Control

#### 3.1. Pan/Tilt/Zoom

Method : GET

Access level : Live

CGI item name	URL	Parameter name	Parameter value	Description
Camera control	/cgi-bin/camctrl	times	1 up down 0	1: Return to default setting up: ZOOM UP one level down: ZOOM DOWN one level 0: Return to default setting
		zoom	1 up down 0	1: Return to default setting up: ZOOM UP one level down: ZOOM DOWN one level 0: Return to default setting
		bright	1 up down -2 0 2	1: Return to default setting up: Turn brightness one level UP down: Turn brightness one level DOWN -2: Turn brightness two levels DOWN 0: Return brightness to standard value (reset) 2: Turn brightness two levels UP
		iris	1 up down -2 0 2	1: Return to default setting up: Turn brightness one level UP down: Turn brightness one level DOWN -2: Turn brightness two levels DOWN 0: Return brightness to standard value (reset) 2: Turn brightness two levels UP
		preset	0 to 100	1 to 100: Preset position number 0: Home position
		focus	-3, 3, on	-3: Near, 3: Far, on: Auto
		af	-3, 3, on	-3: Near, 3: Far, on: Auto
		pan	-5 to 5	A negative value indicates movement to the left, and a positive value indicates movement to the right  * Used together with the tilt parameter
		tilt	-4 to 4	A positive value indicates downward movement and a negative value indicates upward movement  * Used together with the pan parameter

CGI item name	URL	Parameter name	Parameter value	Description
Camera control direct	/cgi-bin/directc trl	pan	-16 to 16	A negative value indicates movement to the left, and a positive value indicates movement to the right * Used together with the tilt parameter
		tilt	-16 to 16	A negative value indicates downward movement and a positive value indicates upward movement * Used together with the pan parameter
		zoom	-4 to 4	A negative value indicates ZOOM DOWN and a positive value indicates ZOOM UP
		focus	-4 to 4	A negative value indicates near and a positive value indicates far

\* This CGI is for backward compatibility. In a remote camera, the use of cgi-bin/aw\_ptz enables high-functionality control. For details, see "HD Integrated Camera Interface Specifications".

## 4. CGI List for Various Settings

### 4.1. Basic Settings

Method : POST/GET

Access level : Admin

CGI item name	URL	Parameter name	Parameter value	Description
Priority mode setting	/cgi-bin/set_priority_mode	mode	ip	ip: IP priority mode
			sdcard	sdcard: SD card priority mode
			usb	usb: USB priority mode
			ip_4k sdcard_4k usb_4k hdmi_4k	ip_4k: IP (4K) priority mode sdcard_4k: SD card (4K) priority mode usb_4k: USB (4K) priority mode hdmi_4k: HDMI (4K) priority mode (*1)
		ndi_hx	ndi_hx:NDI HX priority mode (*2)	
Basic settings	/cgi-bin/set_basic	cam_title	String	Camera title (within 20 double-byte characters)
		plugin_download	enable disable	Auto installation of plug-in software enable: Allowed disable: Not allowed
		plugin_disp	0 1	0: Real time consideration (Off) 1: Smooth display (On)

Usage example) Set the priority mode to IP

[http://192.168.0.10/cgi-bin/set\\_priority\\_mode?mode=ip](http://192.168.0.10/cgi-bin/set_priority_mode?mode=ip)

Usage example) Set the camera title

[http://192.168.0.10/cgi-bin/set\\_basic?cam\\_title=he40](http://192.168.0.10/cgi-bin/set_basic?cam_title=he40)

(\*1): Only for UE70 series

(\*2): HE40 series requires Ver1.6 or later and UE70 series requires Ver1.3 or later.

## 4.2 Clock Settings

Method : POST/GET

Access level : Admin

CGI item name	URL	Parameter name	Parameter value	Description
NTP settings	/cgi-bin/time	time_adjust	0 1	0: Manual 1: Synchronized with the NTP server
		ntp_addr_dhcp	0 1	0: OFF (manual input) 1: ON (acquired from DHCP)
		ntp_addr	String	IP address
		ntp_port	Numeric value	1 to 65535
		ntp_interval	Numeric value	1 to 24 (hours)
Clock settings	/cgi-bin/date_time	display	0 1	0: off 1: on
		date_year	2013 to 2035	Year
		date_month	1 to 12	Month
		date_day	1 to 31	Day
		date_hour	0 to 23	Hour
		date_min	0 to 59	Minutes
		date_sec	0 to 59	Seconds
		timezone	1 to 75	1 to 75
		summer_time	0 1 2	0: Summer time is not set (Out) 1: Summer time is set (In) 2: Summer time is auto-adjusted according to (Start/End) (Auto)
		start_month	1 to 12	1: January to 12: December
		start_week	1 to 5	1: First week, 2: Second week, 3: Third week 4: Fourth week, 5: Last week
		start_dotw	0 to 6	0: Sunday to 6: Saturday
		start_hour	0 to 23	0 to 23
		end_month	1 to 12	1: January to 12: December
		end_week	1 to 5	1: First week, 2: Second week, 3: Third week 4: Fourth week, 5: Last week
		end_dotw	0 to 6	0: Sunday to 6: Saturday
end_hour	0 to 23	0 to 23		

Usage example) NTP settings

[http://192.168.0.10/cgi-bin/time?time\\_adjust=1&ntp\\_addr\\_dhcp=0&ntp\\_addr=192.168.0.1&ntp\\_port=123&ntp\\_interval=12](http://192.168.0.10/cgi-bin/time?time_adjust=1&ntp_addr_dhcp=0&ntp_addr=192.168.0.1&ntp_port=123&ntp_interval=12)

Usage example) Clock settings

[http://192.168.0.10/cgi-bin/date\\_time?display=0&date\\_year=2015&date\\_month=1&date\\_day=1&date\\_hour=0&date\\_min=0&date\\_sec=0&summer\\_time=0](http://192.168.0.10/cgi-bin/date_time?display=0&date_year=2015&date_month=1&date_day=1&date_hour=0&date_min=0&date_sec=0&summer_time=0)

### 4.3. Video over IP Settings

Method : POST

Access level : Admin

CGI item name	URL	Parameter name	Parameter value	Description
JPEG settings	/cgi-bin/set_jpeg	jpeg_quality	0 to 9	0 to 4: High image quality 5 to 9: Low image quality
		jpeg_quality_ch2	0 to 9	0 to 4: High image quality 5 to 9: Low image quality
		jpeg_quality_ch3	0 to 9	0 to 4: High image quality 5 to 9: Low image quality
		resol_stream1	320 640 1280 1920	320: 320 x 180 640: 640 x 360 1280: 1280 x 720 1920: 1920 x 1080
		resol_stream2	320 640 1280	320: 320 x 180 640: 640 x 360 1280: 1280 x 720
		resol_stream3	320 640 1280	320: 320 x 180 640: 640 x 360 1280: 1280 x 720
		jpeg_transmit_1	0 1	0: OFF Do not transmit 1: ON Transmit
		jpeg_transmit_2	0 1	0: OFF Do not transmit 1: ON Transmit
		jpeg_transmit_3	0 1	0: OFF Do not transmit 1: ON Transmit
		jpeg_interval1	5 15(12.5) 30(25)	Frame rate of JPEG(1) 5:5 fps 15 (12.5): 15 (12.5) fps 30 (25): 30 (25) fps * The values within () are for the case when the system frequency is 50 Hz
		jpeg_interval2	5 15(12.5) 30(25)	Frame rate of JPEG(2) 5:5 fps 15 (12.5): 15 (12.5) fps 30 (25): 30 (25) fps * The values within () are for the case when the system frequency is 50 Hz
		jpeg_interval3	5 15(12.5) 30(25)	Frame rate of JPEG(3) 5:5 fps 15 (12.5): 15 (12.5) fps 30 (25): 30 (25) fps * The values within () are for the case when the system frequency is 50 Hz

CGI item name	URL	Parameter name	Parameter value	Description
JPEG stream settings	/cgi-bin/setdata	LIVESIZE	320 640 1280 1920	Resolution of JPEG(1) 320: 320 x 180 640: 640 x 360 1280: 1280 x 720 1920: 1920 x 1080
		LIVESIZE2	320 640 1280	Resolution of JPEG(2) 320: 320 x 180 640: 640 x 360 1280: 1280 x 720
		LIVESIZE3	320 640 1280	Resolution of JPEG(3) 320: 320 x 180 640: 640 x 360 1280: 1280 x 720
		LIVEQUAL1280	0 to 9	Image quality of JPEG(1) 0 to 4: High image quality 5 to 9: Low image quality
		LIVEQUAL640	0 to 9	Image quality of JPEG(2) 0 to 4: High image quality 5 to 9: Low image quality
		LIVEQUAL320	0 to 9	Image quality of JPEG(3) 0 to 4: High image quality 5 to 9: Low image quality
H.264(1) stream settings	/cgi-bin/set_h264	h264_transmit	0 1	0: OFF Do not transmit 1: ON Transmit
		h264_rtsp_mode	0 1	Internet mode settings 0: OFF 1: ON
		h264_resolution	320 640 1280 1920	320: 320 x 180 640: 640 x 360 1280: 1280 x 720 1920: 1920 x 1080
			3840(*1)	3840: 3840 x 2160 (*1): Only for UE70 series
		f_priority	0 1 2	0: Fixed bit rate 1: Frame rate priority 2: Best effort transmission
		framerate	5 15(12.5) 30(25) 60(50)	5: 5 fps 15 (12.5): 15 (12.5) fps 30 (25): 30 (25) fps 60 (50): 60 (50) fps * The values within ( ) are for the case when the system frequency is 50 Hz

CGI item name	URL	Parameter name	Parameter value	Description
		h264_bandwidth	512 768 1024 1536 2048 3072 4096 6144 8192 10240 12288 14336 16384 20480 24576	512:512(kbps) 768:768(kbps) 1024:1024(kbps) 1536:1536(kbps) 2048:2048(kbps) 3072:3072(kbps) 4096:4096(kbps) 6144:6144(kbps) 8192:8192(kbps) 10240:10240(kbps) 12288:12288(kbps) 14336:14336(kbps) 16384:16384(kbps) 20480:20480(kbps) 24576:24576(kbps)
			32768 40960 51200	32768:32768(kbps) 40960:40960(kbps) 51200:51200(kbps)
		h264_bandwidth_min	512 768 1024 1536 2048 3072 4096 6144 8192 10240 12288 14336 16384 20480 24576	512:512(kbps) 768:768(kbps) 1024:1024(kbps) 1536:1536(kbps) 2048:2048(kbps) 3072:3072(kbps) 4096:4096(kbps) 6144:6144(kbps) 8192:8192(kbps) 10240:10240(kbps) 12288:12288(kbps) 14336:14336(kbps) 16384:16384(kbps) 20480:20480(kbps) 24576:24576(kbps)
			32768 40960 51200	32768:32768(kbps) 40960:40960(kbps) 51200:51200(kbps)
		h264_quality	fine low	fine: Image quality priority low: Motion priority
		h264_unimulti	uni multi uni_manual	uni: unicast (auto) multi: multicast uni_manual: unicast (manual)
		unicast_port	1024 to 50000	Port number: 1024 to 50000

CGI item name	URL	Parameter name	Parameter value	Description
		unicast_audio_port	1024 to 50000	Port number: 1024 to 50000
		multicast_addr1	224 to 239	224.0.0.0 - 239.255.255.255
		multicast_addr2	0 to 255	
		multicast_addr3	0 to 255	
		multicast_addr4	0 to 255	
		multicast_addr	*.*.* format *.*.*.*.* format format	*.*.* format *.*.*.*.* format
		multicast_port	1024 to 50000	1024 to 50000
		multicast_ttl	1 to 254	1 to 254
H.264(2) stream settings	/cgi-bin/set_h264_2	h264_transmit	01	0: OFF Do not transmit 1: ON Transmit
		h264_rtsp_mode	0 1	Internet mode settings 0: OFF 1: ON
		h264_resolution	320 640 1280	320:320x180 640:640x360 1280:1280x720
		f_priority	0 1 2	0: Fixed bit rate 1: Frame rate priority 2: Best effort transmission
		framerate	5 15 (12.5) 30 (25)	5: 5 fps 15 (12.5): 15 (12.5) fps 30 (25): 30 (25) fps * The values within () are for the case when the system frequency is 50 Hz



CGI item name	URL	Parameter name	Parameter value	Description
		h264_bandwidth	512 768 1024 1536 2048 3072 4096 6144 8192 10240 12288 14336 16384 20480 24576	512:512(kbps) 768:768(kbps) 1024:1024(kbps) 1536:1536(kbps) 2048:2048(kbps) 3072:3072(kbps) 4096:4096(kbps) 6144:6144(kbps) 8192:8192(kbps) 10240:10240(kbps) 12288:12288(kbps) 14336:14336(kbps) 16384:16384(kbps) 20480:20480(kbps) 24576:24576(kbps)
		h264_bandwidth_min	512 768 1024 1536 2048 3072 4096 6144 8192 10240 12288 14336 16384 20480 24576	512:512(kbps) 768:768(kbps) 1024:1024(kbps) 1536:1536(kbps) 2048:2048(kbps) 3072:3072(kbps) 4096:4096(kbps) 6144:6144(kbps) 8192:8192(kbps) 10240:10240(kbps) 12288:12288(kbps) 14336:14336(kbps) 16384:16384(kbps) 20480:20480(kbps) 24576:24576(kbps) * Can be set when f_priority = 2 (Best effort transmission)
		h264_quality	fine low	fine: Image quality priority low: Motion priority
		h264_unimulti	uni multi uni_manual	uni: unicast (auto) multi: multicast uni_manual: unicast (manual)
		unicast_port	1024 to 50000	Port number: 1024 to 50000
		unicast_audio_port	1024 to 50000	Port number: 1024 to 50000
		multicast_address_r1	224 to 239	224.0.0.0 - 239.255.255.255
		multicast_address_r2	0 to 255	
		multicast_address	0 to 255	

CGI item name	URL	Parameter name	Parameter value	Description
		r3		
		multicast_add r4	0 to 255	
		multicast_add r	*.*.* format *.*.*.*.* format format	*.*.* format *.*.*.*.* format
		multicast_port	1024 to 50000	1024 to 50000
		multicast_ttl	1 to 254	1 to 254
H.264(3) stream settings	/cgi-bin/set_h264 _3	h264_transmit	0 1	0: OFF Do not transmit 1: ON Transmit
		h264_rtsp_m ode	0 1	Internet mode settings 0: OFF 1: ON
		h264_resoluti on	320 640 1280	320:320x180 640:640x360 1280:1280x720
		f_priority	0 1 2	0: Fixed bit rate 1: Frame rate priority 2: Best effort transmission
		framerate	5 15 (12.5) 30 (25)	5: 5 fps 15 (12.5): 15 (12.5) fps 30 (25): 30 (25) fps * The values within ( ) are for the case when the system frequency is 50 Hz
		h264_bandwi dth	512 768 1024 1536 2048 3072 4096 6144 8192 10240 12288 14336 16384 20480 24576	512:512(kbps) 768:768(kbps) 1024:1024(kbps) 1536:1536(kbps) 2048:2048(kbps) 3072:3072(kbps) 4096:4096(kbps) 6144:6144(kbps) 8192:8192(kbps) 10240:10240(kbps) 12288:12288(kbps) 14336:14336(kbps) 16384:16384(kbps) 20480:20480(kbps) 24576:24576(kbps)

CGI item name	URL	Parameter name	Parameter value	Description
		h264_bandwidth_min	512 768 1024 1536 2048 3072 4096 6144 8192 10240 12288 14336 16384 20480 24576	512:512(kbps) 768:768(kbps) 1024:1024(kbps) 1536:1536(kbps) 2048:2048(kbps) 3072:3072(kbps) 4096:4096(kbps) 6144:6144(kbps) 8192:8192(kbps) 10240:10240(kbps) 12288:12288(kbps) 14336:14336(kbps) 16384:16384(kbps) 20480:20480(kbps) 24576:24576(kbps) * Can be set when f_priority = 2 (Best effort transmission)
		h264_quality	fine low	fine: Image quality priority low: Motion priority
		h264_unimulti	uni multi uni_manual	uni: unicast (auto) multi: multicast uni_manual: unicast (manual)
		unicast_port	1024 to 50000	Port number: 1024 to 50000
		unicast_audio_port	1024 to 50000	Port number: 1024 to 50000
		multicast_addr1	224 to 239	224.0.0.0 - 239.255.255.255
		multicast_addr2	0 to 255	
		multicast_addr3	0 to 255	
		multicast_addr4	0 to 255	
		multicast_addr	*.*.* format *.*.*.*.* format format	*.*.* format *.*.*.*.* format
		multicast_port	1024 to 50000	1024 to 50000
		multicast_ttl	1 to 254	1 to 254
H.264(4) stream settings	/cgi-bin/set_h264_4	h264_transmit	0 1	0: OFF Do not transmit 1: ON Transmit
		h264_rtsp_mode	0 1	Internet mode settings 0: OFF 1: ON

CGI item name	URL	Parameter name	Parameter value	Description
		h264_resolution	320 640 1280	320:320x180 640:640x360 1280:1280x720
		f_priority	0 1 2	0: Fixed bit rate 1: Frame rate priority 2: Best effort transmission
		framerate	5 15 (12.5) 30 (25)	5: 5 fps 15 (12.5): 15 (12.5) fps 30 (25): 30 (25) fps * The values within ( ) are for the case when the system frequency is 50 Hz
		h264_bandwidth	512 768 1024 1536 2048 3072 4096 6144 8192 10240 12288 14336 16384 20480 24576	512:512(kbps) 768:768(kbps) 1024:1024(kbps) 1536:1536(kbps) 2048:2048(kbps) 3072:3072(kbps) 4096:4096(kbps) 6144:6144(kbps) 8192:8192(kbps) 10240:10240(kbps) 12288:12288(kbps) 14336:14336(kbps) 16384:16384(kbps) 20480:20480(kbps) 24576:24576(kbps)
		h264_bandwidth_min	512 768 1024 1536 2048 3072 4096 6144 8192 10240 12288 14336 16384 20480 24576	512:512(kbps) 768:768(kbps) 1024:1024(kbps) 1536:1536(kbps) 2048:2048(kbps) 3072:3072(kbps) 4096:4096(kbps) 6144:6144(kbps) 8192:8192(kbps) 10240:10240(kbps) 12288:12288(kbps) 14336:14336(kbps) 16384:16384(kbps) 20480:20480(kbps) 24576:24576(kbps) * Can be set when f_priority = 2 (Best effort transmission)
		h264_quality	fine low	fine: Image quality priority low: Motion priority

CGI item name	URL	Parameter name	Parameter value	Description
		h264_unimulti	uni multi uni_manual	uni: unicast (auto) multi: multicast uni_manual: unicast (manual)
		unicast_port	1024 to 50000	Port number: 1024 to 50000
		unicast_audio_port	1024 to 50000	Port number: 1024 to 50000
		multicast_addr1	224 to 239	224.0.0.0 - 239.255.255.255
		multicast_addr2	0 to 255	
		multicast_addr3	0 to 255	
		multicast_addr4	0 to 255	
		multicast_addr	*.*.*.* format*.*.*.*.* .*.* format	*.*.*.* format*.*.*.*.* format
		multicast_port	1024 to 50000	1024 to 50000
		multicast_ttl	1 to 254	1 to 254
RTSP settings	/cgi-bin/set_rtsp	rtsp_port	1 to 65535	1 to 65535 * Set to 554 according to factory settings
		h264_rtsp_mode	0 1	Internet mode settings of H264(1) 0: OFF Do not Transmit 1: ON Transmit
		h264_rtsp_mode2	0 1	Internet mode settings of H264(2) 0: OFF Do not Transmit 1: ON Transmit
		h264_rtsp_mode3	0 1	Internet mode settings of H264(3) 0: OFF Do not Transmit 1: ON Transmit
		h264_rtsp_mode4	0 1	Internet mode settings of H264(4) 0: OFF Do not Transmit 1: ON Transmit
Live screen initial stream selection	/cgi-bin/set_livestart	stream	h264 h264_2 h264_3 h264_4 jpeg jpeg_2 jpeg_3	h264:H264(1) h264_2:H.264(2) h264_3:H.264(3) h264_4:H.264(4) jpeg:JPEG(1) jpeg_2:JPEG(2) jpeg_3:JPEG(3)

Usage example) Change the resolution of H.264(4) to 320 x 180.

[http://192.168.0.10/cgi-bin/set\\_h264\\_4?h264\\_resolution=320](http://192.168.0.10/cgi-bin/set_h264_4?h264_resolution=320)

\* This command requires a request by POST.

Usage example) Change the RTSP waiting port at the remote camera side from 554(factory settings) to 555.

[http://192.168.0.10/cgi-bin/set\\_rtsp?rtsp\\_port=555](http://192.168.0.10/cgi-bin/set_rtsp?rtsp_port=555)

\* This command requires a request by POST.

\* The h264\_rtsp\_mode of set\_rtsp is a mirror of the WEB menu. RTSP/RTP does not change to TCP even if turned ON.

## 4.4. Audio Settings

Method : POST

Access level : Admin

CGI item name	URL	Parameter name	Parameter value	Description
Audio settings	/cgi-bin/set_audio	audio	off in 0 1	off: OFF in: ON 0: OFF 1: ON
		audio_encoder	aac	Encoder settings AAC (fixed)
		audio_sens	low middle high line_low line_middle line_high	low: Mic Low middle: Mic Middle high: Mic High line_low: Line Low line_middle: Line Middle line_high: Line High
		audio_bitrate	64 96 128	64: 64 Kbps 96: 96 Kbps 128: 128 Kbps
		audio_alc	0 1	0: ALC settings OFF 1: ALC settings ON
		plugin_power	0 1	0: Off 1: On
		audio_transmit	0 1	0: Off 1: On
		equalizer	off low_cut speech_enhancement	off: Off low_cut: Low cut speech_enhancement: Audio enhancement

Usage example) Turn ON the Audio input signal from the device connected to the AUDIO IN terminal.

[http://192.168.0.10/cgi-bin/set\\_audio?audio=1](http://192.168.0.10/cgi-bin/set_audio?audio=1)

The control relationship with each parameter is as described below.

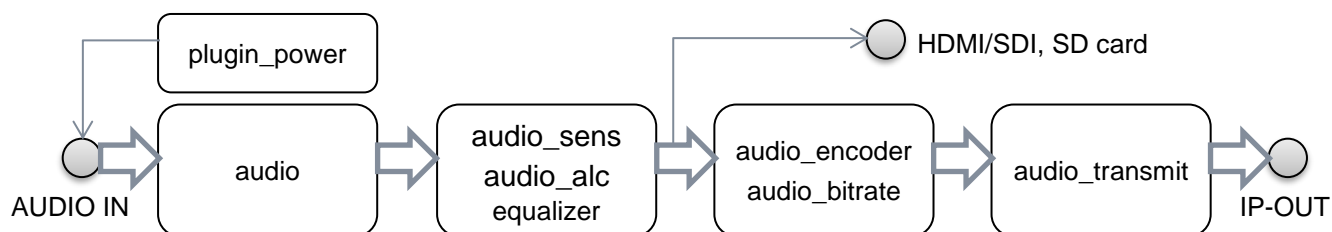

## 4.5. Multi-screen Settings

Method : POST

Access level : Admin

CGI item name	URL	Parameter name	Parameter value	Description
Multi-screen settings	/cgi-bin/multi_screen	multi_addr1	"*.*.*" format	"*.*.*" format or "*.*.*: 1 to 65535" or "String" or "String": 1 to 65535"
		multi_addr2	or	
		multi_addr3	"*.*.*: 1 to	
		multi_addr4	65535" or	
		multi_addr5	"String" or	
		multi_addr6	"String": 1 to	
		multi_addr7	65535"	
		multi_addr8		
		multi_addr9		
		multi_addr10		
		multi_addr11		
		multi_addr12		
		multi_addr13		
		multi_addr14		
		multi_addr15		
		multi_addr16		
		multi_name1	String (within 20 double-byte characters)	Name of the camera
		multi_name2		
		multi_name3		
		multi_name4		
		multi_name5		
		multi_name6		
		multi_name7		
		multi_name8		
		multi_name9		
		multi_name10		
		multi_name11		
		multi_name12		
		multi_name13		
		multi_name14		
		multi_name15		
		multi_name16		

Usage example) Set 192.168.0.100/he40 in the first frame.

[http://192.168.0.10/cgi-bin/multi\\_screen?multi\\_addr1=192.168.0.100&multi\\_name1=he40](http://192.168.0.10/cgi-bin/multi_screen?multi_addr1=192.168.0.100&multi_name1=he40)



## 4.6. Priority Stream Settings

Method : POST

Access level : Admin

CGI item name	URL	Parameter name	Parameter value	Description
Priority stream settings	/cgi-bin/set_priority2	priority	0 1	0: Priority stream OFF 1: Priority stream ON
		ip_addr	"*.*.*" format or "*.*.*.*.*" format	"*.*.*" format or "*.*.*.*.*" format
		ip_addr2	"*.*.*" format or "*.*.*.*.*" format	"*.*.*" format or "*.*.*.*.*" format
		stream_type	jpeg jpeg2 jpeg3 h264 h264_2 h264_3 h264_4	jpeg: JPEG jpeg2: JPEG(2) jpeg3: JPEG(3) h264: H.264(1) h264_2: H.264(2) h264_3: H.264(3) h264_4: H.264(4)

Usage example) The transmission of H264(1) to 192.168.0.99 is implemented on priority.

[http://192.168.0.10/cgi-bin/set\\_priority2?priority=1&ip\\_addr=192.168.0.99&stream\\_type=h264](http://192.168.0.10/cgi-bin/set_priority2?priority=1&ip_addr=192.168.0.99&stream_type=h264)

## 4.7. Network Settings

Method : POST

Access level : Admin

CGI item name	URL	Parameter name	Parameter value	Description
Network settings	/cgi-bin/network	dhcp	0 1	0: DHCP OFF (Static settings) 1: DHCP ON
		IP_addr1	0 to 255	IP address First octet
		IP_addr2	0 to 255	IP address Second octet
		IP_addr3	0 to 255	IP address Third octet
		IP_addr4	0 to 255	IP address Fourth octet
		netmask1	0 to 255	Subnet mask First octet
		netmask2	0 to 255	Subnet mask Second octet
		netmask3	0 to 255	Subnet mask Third octet
		netmask4	0 to 255	Subnet mask Fourth octet
		gateway1	0 to 255	Default gateway First octet
		gateway2	0 to 255	Default gateway Second octet
		gateway3	0 to 255	Default gateway Third octet
		gateway4	0 to 255	Default gateway Fourth octet
		port	1 to 65535	1 to 65535
		dns	manual auto	manual: Manual setting auto: Auto setting
		pri_server1	0 to 255	Primary server address (DNS) First octet
		pri_server2	0 to 255	Primary server address (DNS) Second octet
		pri_server3	0 to 255	Primary server address (DNS) Third octet
		pri_server4	0 to 255	Primary server address (DNS) Fourth octet
		sec_server1	0 to 255	Secondary server address (DNS) First octet
		sec_server2	0 to 255	Secondary server address (DNS) Second octet
sec_server3	0 to 255	Secondary server address (DNS) Third octet		
sec_server4	0 to 255	Secondary server address (DNS) Fourth octet		
ip6_auto	0 1	IPv6 address manual setting 1: off 0: on		
ip6_addr	*.*.*.*.*.*.*.* format	IP address		

CGI item name	URL	Parameter name	Parameter value	Description
		ip6_gateway	*.*.*.*.*.*.*.* format	Default gateway
		ip6_pri_server	*.*.*.*.*.*.*.* format	Primary server (IPv6 only)
		ip6_sec_server	*.*.*.*.*.*.*.* format	Secondary server (IPv6 only)
		ip6_dhcp	0 1	0: DHCPv6 OFF 1: DHCPv6 ON
		rtp_packet_max	1500 1280	RTP packet max. transmission size 1500: Unlimited (1500 byte) 1280: Limited (1280 byte)
		mss	1460 1280 1024	Max. segment size of TCP (MSS) 1460: Unlimited (1460 byte) 1280: Limited (1280 byte) 1024: Limited (1024 byte)
		time	20 unlimited	Effective limit 20: 20 minutes unlimited: Unlimited
		bandwidth	0 64 128 256 384 512 768 1024 2048 4096 8192 10000	Transmission volume of entire network 0: Unlimited 64: 64kbps 128: 128kbps 256: 256kbps 384: 384kbps 512: 512kbps 768: 768kbps 1024: 1024kbps 2048: 2048kbps 4096: 4096kbps 8192: 8192kbps 10000: Unlimited  * When 10000 is received, an error is not issued, and the operation is performed by assuming "Unlimited".
Easy IP Setup protocol settings	/cgi-bin/easyipset	time	unlimited, 20	Time period during which Easy IP Setup can be performed from the time power is turned ON unlimited: Unlimited 20: 20 minutes

CGI item name	URL	Parameter name	Parameter value	Description
Transmission volume of entire network	/cgi-bin/set_bandwidth	bandwidth	0 1024 2048 4096 8192 16384 32768 10000	Transmission volume of entire network 0: Unlimited 1024: 1024kbps 2048: 2048kbps 4096: 4096kbps 8192: 8192kbps 16384: 16384kbps 32768: 32768kbps 10000: Unlimited  * When 10000 is received, an error is not issued, and the operation is performed by assuming "Unlimited".
Max. packet length settings	/cgi-bin/set_rtp	rtp_size	1280 1500	1280: Max. packet length limit 1500: Normal packet length

Usage example) Change the IP address to 192.168.0.30

`http://192.168.0.10/cgi-bin/network?IP_addr1=192&IP_addr2=168&IP_addr3=0&IP_addr4=30&netmask1=255&netmask2=255&netmask3=255&netmask4=128&gateway1=192&gateway2=168&gateway3=0&gateway4=50`

## 4.8. UPnP Settings

Method : POST

Access level : Admin

CGI item name	URL	Parameter name	Parameter value	Description
UPnP settings	/cgi-bin/upnp	upnp_portmap	0 1	Auto port-forwarding 0: Disabled 1: Enabled

Usage example) Set UPnP to ON

[http://192.168.0.10/cgi-bin/upnp?upnp\\_portmap=1](http://192.168.0.10/cgi-bin/upnp?upnp_portmap=1)

## 4.9. Restarting

Method : POST/GET

Access level : Admin

CGI item name	URL	Parameter name	Parameter value	Description
Initialization	/cgi-bin/initial	cmd	reset	Camera restart
		Randomnum	Hexadecimal string	16 single-byte character string

Usage example) Restarting the remote camera

<http://192.168.0.10/cgi-bin/initial?cmd=reset&Randomnum=12345>

## 5. CGI List for Acquisition of Different Types of Information

### 5.1. Basic Settings Information Acquisition

Method : GET

Access level : Live

CGI item name	URL	Parameter name	Parameter value	Description
Basic settings information acquisition	/cgi-bin/get_basics			

The response data is as shown below.

cam\_title = Camera title

plugin\_download = enable/disable

plugin\_disp = 0/1

### 5.2. NTP Settings Information Acquisition

Method : GET

Access level : Admin

CGI item name	URL	Parameter name	Parameter value	Description
NTP settings information acquisition	/cgi-bin/get_time			

The response data is as shown below.

time\_adjust = 0/1

ntp\_addr\_dhcp = 0/1

ntp\_addr = String

ntp\_port = Numeric value (1 to 65535)

ntp\_interval = Numeric value (1 to 24)

### 5.3. Clock Settings Information Acquisition

Method : GET

Access level : Live

CGI item name	URL	Parameter name	Parameter value	Description
Clock settings information acquisition	/cgi-bin/get_date_time			

The response data is as shown below.

display = 0/1  
date\_year = Numeric value  
date\_month = Numeric value  
date\_day = Numeric value  
date\_hour = Numeric value  
date\_min = Numeric value  
date\_sec = Numeric value  
timezone = Numeric value (1 to 74)  
summer\_time = 0/1/2  
start\_month = Numeric value  
start\_week = Numeric value (1 to 5)  
start\_dotw = Numeric value (0 to 6)  
start\_hour = (0 to 23)  
end\_month = Numeric value  
end\_week = Numeric value (1 to 5)  
end\_dotw = Numeric value (0 to 6)  
end\_hour = Numeric value (0 to 23)  
is\_summer\_time = 0/1 (0: OFF, 1: ON)

### 5.4. Priority Mode Acquisition

Method : GET

Access level : Live

CGI item name	URL	Parameter name	Parameter value	Description
Priority mode acquisition	/cgi-bin/get_priority_mode			

The response data is as shown below.

priority\_mode = xxx  
\* For details on the value notified by xxx, see the parameters of set\_priority\_mode.

## 5.5. VideoOverIP Screen Information Acquisition

Method : GET

Access level : Live

CGI item name	URL	Parameter name	Parameter value	Description
VideoOverIP screen information acquisition	/cgi-bin/get_video_over_ip			<ul style="list-style-type: none"> <li>The response is issued in a random order</li> <li>If transmission to a specific ch is not possible due to the specifications, the response for the desired ch is not returned</li> </ul> <p>Example) If transmission to h264 (ch4) is not possible, h264_xxxxx_ch4 is not included in the response.</p>

The response data is as shown below.

```

livestart_stream=h264/h264_2/h264_3/h264_4/jpeg/jpeg_2/jpeg_3
jpeg_quality=1/5
jpeg_quality_ch2=1/5
jpeg_quality_ch3=1/5
resol_stream1=320/640/1280/1920
resol_stream2=320/640/1280
resol_stream3=320/640/1280
jpeg_transmit1=0/1
jpeg_transmit2=0/1
jpeg_transmit3=0/1
jpeg_interval1=5/15(12.5)/30(25)
jpeg_interval2=5/15(12.5)/30(25)
jpeg_interval3=5/15(12.5)/30(25)
h264_transmit_ch1=0/1
h264_transmit_ch2=0/1
h264_transmit_ch3=0/1
h264_transmit_ch4=0/1
h264_rtsp_mode_ch1=0/1
h264_rtsp_mode_ch2=0/1
h264_rtsp_mode_ch3=0/1
h264_rtsp_mode_ch4=0/1
h264_resolution_ch1=320/640/1280/1920/3840(*1)
h264_resolution_ch2=320/640/1280
h264_resolution_ch3=320/640/1280
h264_resolution_ch4=320/640/1280
h264_f_priority_ch1=0/1/2
h264_f_priority_ch2=0/1/2
h264_f_priority_ch3=0/1/2

```



h264\_f\_priority\_ch4=0/1/2  
h264\_framerate\_ch1=5/15(12.5)/30(25)/60(50)  
h264\_framerate\_ch2=5/15(12.5)/30(25)  
h264\_framerate\_ch3=5/15(12.5)/30(25)  
h264\_framerate\_ch4=5/15(12.5)/30(25)  
h264\_bandwidth\_ch1 = Numeric value  
h264\_bandwidth\_ch2 = Numeric value  
h264\_bandwidth\_ch3 = Numeric value  
h264\_bandwidth\_ch4 = Numeric value  
h264\_bandwidth\_min\_ch1 = Numeric value  
h264\_bandwidth\_min\_ch2 = Numeric value  
h264\_bandwidth\_min\_ch3 = Numeric value  
h264\_bandwidth\_min\_ch4 = Numeric value  
h264\_quality\_ch1=fine/low1/5  
h264\_quality\_ch2=fine/low1/5  
h264\_quality\_ch3=fine/low1/5  
h264\_quality\_ch4=fine/low1/5  
h264\_unimulti\_ch1=uni/multi/uni\_manual  
h264\_unimulti\_ch2=uni/multi/uni\_manual  
h264\_unimulti\_ch3=uni/multi/uni\_manual  
h264\_unimulti\_ch4=uni/multi/uni\_manual  
h264\_unicast\_port\_ch1 = Numeric value (1024 to 50000)  
h264\_unicast\_port\_ch2 = Numeric value (1024 to 50000)  
h264\_unicast\_port\_ch3 = Numeric value (1024 to 50000)  
h264\_unicast\_port\_ch4 = Numeric value (1024 to 50000)  
h264\_unicast\_audio\_port\_ch1 = Numeric value (1024 to 50000)  
h264\_unicast\_audio\_port\_ch2 = Numeric value (1024 to 50000)  
h264\_unicast\_audio\_port\_ch3 = Numeric value (1024 to 50000)  
h264\_unicast\_audio\_port\_ch4 = Numeric value (1024 to 50000)  
h264\_multicast\_addr\_ch1=xxx.xxx.xxx.xxx  
h264\_multicast\_addr\_ch2=xxx.xxx.xxx.xxx  
h264\_multicast\_addr\_ch3=xxx.xxx.xxx.xxx  
h264\_multicast\_addr\_ch4=xxx.xxx.xxx.xxx  
h264\_multicast\_port\_ch1 = Numeric value (1024 to 50000)  
h264\_multicast\_port\_ch2 = Numeric value (1024 to 50000)  
h264\_multicast\_port\_ch3 = Numeric value (1024 to 50000)  
h264\_multicast\_port\_ch4 = Numeric value (1024 to 50000)  
h264\_multicast\_ttl\_ch1 = Numeric value (1 to 254)  
h264\_multicast\_ttl\_ch2 = Numeric value (1 to 254)  
h264\_multicast\_ttl\_ch3 = Numeric value (1 to 254)  
h264\_multicast\_ttl\_ch4 = Numeric value (1 to 254)

(\*1): Only for UE70 series

## 5.6. Audio Settings Information Acquisition

Method : GET

Access level : Live

CGI item name	URL	Parameter name	Parameter value	Description
Audio settings information acquisition	/cgi-bin/get_audio			

The response data is as shown below.

```
audio=0/1/off/in
audio_sens=low/middle/high/line_low/line_middle/line_high
plugin_power=0/1
audio_alc=0/1
equalizer=off/low_cut/speech_enhancement
audio_transmit=0/1
audio_bitrate=64/96/128
```

## 5.7. Multi-screen Settings Information Acquisition

Method : GET

Access level : Live

CGI item name	URL	Parameter name	Parameter value	Description
Multi-screen settings information acquisition	/cgi-bin/get_multi_screen			

The response data is as shown below.

```
multi_addr1 = ".*.*.*" format/"*.*.*": 1 to 65535"/"String"/"String": 1 to 65535"
multi_name1 = String (within 20 double-byte characters)
multi_addr2 = ".*.*.*" format/"*.*.*": 1 to 65535"/"String"/"String": 1 to 65535"
multi_name2 = String (within 20 double-byte characters)
multi_addr3 = ".*.*.*" format/"*.*.*": 1 to 65535"/"String"/"String": 1 to 65535"
multi_name3 = String (within 20 double-byte characters)
multi_addr4 = ".*.*.*" format/"*.*.*": 1 to 65535"/"String"/"String": 1 to 65535"

...

multi_addr16 = ".*.*.*" format/"*.*.*": 1 to 65535"/"String"/"String": 1 to 65535"
multi_name16 = String (within 20 double-byte characters)
```



## 5.10. Network Settings Information Acquisition

Method : GET  
 Access level : Admin

CGI item name	URL	Parameter name	Parameter value	Description
Network settings information acquisition	/cgi-bin/get_network			

The response data is as shown below.

```

ip4_dhcp=0/1
ip4_addr=*. *.*.*
ip4_netmask=*. *.*.*
ip4_gateway=*. *.*.*
dns=auto/manual
ip4_pri_server=*. *.*.*
ip4_sec_server=*. *.*.*
ip6_auto=0/1
ip6_addr=*. *.*.*.*.*.*.*
ip6_gateway=*. *.*.*.*.*.*.*
ip6_dhcp=0/1
ip6_pri_server=*. *.*.*.*.*.*.*
ip6_sec_server=*. *.*.*.*.*.*.*
port = Numeric value (1 to 65535)
rtp_packet_max=1500/1280
mss=1024/1280/1460
bandwidth=0/64/128/256/384/512/768/1024/2048/4096/8192
time=20/unlimited
  
```

## 5.11. UPnP Settings Information Acquisition

Method : GET  
 Access level : Admin

CGI item name	URL	Parameter name	Parameter value	Description
UPnP settings information acquisition	/cgi-bin/get_upnp			

The response data is as shown below.

```

upnp_portmap = 0/1
  
```

## 5.12. System Log Information Acquisition

Method : GET  
Access level : Admin

CGI item name	URL	Parameter name	Parameter value	Description
System log	/cgi-bin/get_syst emlog	type	eventlog errorlog	eventlog: Event log errorlog: Error log
		num	Numeric value (1 to 100)	Acquisition number
		index	Numeric value (1 to 100)	Acquisition start position

The response data is as shown below.

no\mm/dd/yyyy hh:mm\event code\description\$no\mm/dd/yyyy hh:mm\event code\description\$

- 
- 
- 

\* No line feed.

A "\" is entered between two parameters.

A "\$" is entered between numbers, such as between No. 1 and No. 2.

## 5.13. Camera Status Acquisition

Method : GET

Access level : Live

CGI item name	URL	Parameter name	Parameter value	Description
Camera status acquisition	/cgi-bin/get_stat e			rec: Is recording in progress or not rec_counter: Recording elapsed time ftp_send: Is FTP transfer in progress or not play: Is playback in progress or not del_file: Is file deletion in progress or not download: Is download in progress or not sd_format: Is SD card formatting in progress or not sd_insert: Has SD card been inserted or not sd_repair: Is SD card being repaired or not sd_error: Is SD card in error state or not sd_rem: SD card remaining amount [Gbyte] sd_org: SD card capacity [Gbyte]

The response data is as shown below.

```

rec=on/off
rec_counter=hh:mm:ss
ftp_send=on/off
play=on/off
del_file=on/off
download=on/off
sd_format=on/off
sd_insert=on/off
sd_repair=on/off
sd_error=on/off
sd_rem = xx/ ----- (xx: Remaining amount [Gbyte])
sd_org = yy/ ----- (yy: Capacity [Gbyte])
    
```

## 5.14. UPnP Execution Results Acquisition

Method : GET  
Access level : Admin

CGI item name	URL	Parameter name	Parameter value	Description
Status acquisition	/cgi-bin/get_status	-	-	UPnP execution result

The response data is as shown below.

http\_port = Numeric value  
http\_status = enable/disable  
https\_port = Numeric value  
https\_status = enable/disable  
addr = String

## 5.15. Preset Position Information Acquisition

Method : GET  
Access level : Admin

CGI item name	URL	Parameter name	Parameter value	Description
Preset position information acquisition	/cgi-bin/get_preset_position_info	command	list	list: Preset position registration status acquisition

The response data is as shown below.

PRESET\_POSITION\_REGISTRATION = String  
HOME = 0  
POS11\_ID = xxx  
POS12\_ID = xxx  
▪  
▪  
▪  
POS1100ID = xxx

## 5.16. Other Setting Values Acquisition

Method : GET  
Access level : Admin

CGI item name	URL	Parameter name	Parameter value	Description
Setting value acquisition CGI	/cgi-bin/getdata	req	-	Specify the item name of the setting value to be acquired.
			img_mode	Imaging mode
			imgratio	Image ratio
			img_fps	Frame rate
			livestream	Live screen initial stream selection
			liveint	liveint: JPEG(1) refresh interval
			livequalbase	livequalbase: JPEG(1) default image quality
			livesize	livesize: JPEG(1) image resolution
			livequal	livequal: JPEG(1) image quality
			livesize2	livesize: JPEG(2) image resolution
			livequal2	livequal: JPEG(2) image quality
			livesize3	livesize: JPEG(3) image resolution
			livequal3	livequal: JPEG(3) image quality
			h264	H264(1) transmission ON/OFF
			h264rtspmode	Internet mode (H.264 transmission 1) ON/OFF
			h264bwc	Bit rate per client
			nrh264bwc	Bit rate per client at which transmission does not stop
			h264bwcmmin	H.264(1) Bit rate per client (minimum)
			h264rtspmode_2	h264rtspmode_2: Internet mode (H.264 transmission 2) ON/OFF
			h264rtspmode_3	h264rtspmode_3: Internet mode (H.264 transmission 3) ON/OFF
			h264rtspmode_4	h264rtspmode_4: Internet mode (H.264 transmission 4) ON/OFF
			rtspport	rtspport: RTSP server port number
			h264size	h.264size: h.264 resolution
			h264qual	h.264qual: h.264 image quality
			h264rint	h.264rint: Refresh cycle (I frame cycle)
			h264mtd	h.264mtd: h.264 transmission method
			h264mladd1	h.264mladd1: h.264 multicast address First octet
h264mladd2	h.264mladd2: h.264 multicast			



CGI item name	URL	Parameter name	Parameter value	Description
				address Second octet
			h264mladd3	h.264mladd3: h.264 multicast address Third octet
			h264mladd4	h.264mladd4: h.264 multicast address Fourth octet
			h264mlport	h.264mlport: h.264 multicast transmission destination port number
			h264mlttl	h.264mlttl: h.264 multicast TTL
			h264uniport	h.264uniport: Unicast (for video) port number
			h264uniport2	h.264uniport2: Unicast (for audio) port number
			h264profile	H.264 profile
			h264codind	H.264 encoding system
			h264_2	h.264_2: h.264 transmission ON/OFF 2
			h264bwc_2	h.264bwc_2: Bit rate per client 2
			h264size_2	h.264size_2: h.264 resolution 2
			h264qual_2	h.264qual_2: h.264 image quality 2
			h264rint_2	h.264rint_2: Refresh cycle (1 frame cycle) 2
			h264mtd_2	h.264mtd: h.264 transmission method 2
			h264mladd1_2	h.264mladd1_2: h.264 multicast address First octet 2
			h264mladd2_2	h.264mladd2_2: h.264 multicast address Second octet 2
			h264mladd3_2	h.264mladd3_2: h.264 multicast address Third octet 2
			h264mladd4_2	h.264mladd4_2: h.264 multicast address Fourth octet 2
			h264mlport_2	h.264mlport_2: h.264 multicast transmission destination port number 2
			h264mlttl_2	h.264mlttl_2: h.264 multicast TTL2
			h.264uniport_2	h.264uniport_2: Unicast (for video) port number 2
			h264uniport2_2	h.264uniport2_2: Unicast (for audio) port number 2
			h264profile_2	H.264 profile 2
			h264codind_2	H.264 encoding system 2
			h264_3	h.264_2: h.264 transmission

CGI item name	URL	Parameter name	Parameter value	Description
				ON/OFF 3
			h264bwc_3	h.264bwc_3: Bit rate per client 3
			h264size_3	h.264size_3: h.264 resolution 3
			h264qual_3	h.264qual_3: h.264 image quality 3
			h264rint_3	h.264rint_3: Refresh cycle (1 frame cycle) 3
			h264mtd_3	h.264mtd_3: h.264 transmission method 3
			h264mladd1_3	h.264mladd1_3: h.264 multicast address First octet 3
			h264mladd2_3	h.264mladd2_3: h.264 multicast address Second octet 3
			h264mladd3_3	h.264mladd3_3: h264 multicast address Third octet 3
			h264mladd4_3	h.264mladd4_3: h264 multicast address Fourth octet 3
			h264mlport_3	h.264mlport_3: h264 multicast transmission destination port number 3
			h264mlttl_3	h264mlttl_3: h264 multicast TTL3
			h.264uniport_3	h.264uniport_3: Unicast (for video) port number 3
			h264uniport2_3	h.264uniport2_3: Unicast (for audio) port number 3
			h264profile_3	H.264 profile 3
			h264codind_3	H.264 encoding system 3
			h264_4	h.264_4: h.264 transmission ON/OFF 4
			h264bwc_4	h.264bwc_4: Bit rate per client 4
			h264size_4	h.264size_4: h.264 resolution 4
			h264qual_4	h.264qual_4: h.264 image quality 4
			h264rint_4	h.264rint_4: Refresh cycle (1 frame cycle) 4
			h264mtd_4	h.264mtd_4: h.264 transmission method 4
			h264mladd1_4	h.264mladd1_4: h.264 multicast address First octet 4
			h264mladd2_4	h.264mladd2_4: h.264 multicast address Second octet 4
			h264mladd3_4	h.264mladd3_4: h264 multicast address Third octet 4
			h264mladd4_4	h.264mladd4_4: h264 multicast address Fourth octet 4

CGI item name	URL	Parameter name	Parameter value	Description
			h264mlport_4	h264mlport_4: h264 multicast transmission destination port number 4
			h264mlttl_4	h264mlttl_4: h264 multicast TTL4
			h.264uniport_4	h.264uniport_4: Unicast (for video) port number 4
			h264uniport2_4	h.264uniport2_4: Unicast (for audio) port number 4
			h264profile_4	H.264 profile 4
			h264codind_4	H.264 encoding system 4
			h264mlauto	H264(1) multicast auto start
			h264mlauto_2	H264(2) multicast auto start
			h264mlauto_3	H264(3) multicast auto start
			h264mlauto_4	H264(4) multicast auto start
			audio_level	audio_level: Audio authorization and authentication level setting
			audio_sens	audio_sens: Sound collection sensitivity
			nrlivequal	nrlivequal: JPEG image quality at which transmission does not stop
			nrh264size	nrh264size: H.264 resolution at which transmission does not stop
			nrh264qual	nrh264qual: H.264 image quality at which transmission does not stop
			nrh264bwc_2	nrh264bwc_2: Bit rate per client 2 at which transmission does not stop
			nrh264size_2	nrh264size_2: H.264 resolution 2 at which transmission does not stop
			nrh264qual_2	nrh264qual_2: H.264 image quality 2 at which transmission does not stop
			nrh264bwc_3	nrh264bwc_3: Bit rate per client 3 at which transmission does not stop
			nrh264size_3	nrh264size_3: H.264 resolution 3 at which transmission does not stop
			nrh264qual_3	nrh264qual_3: H.264 image quality 3 at which transmission does not stop
			nrh264bwc_4	nrh264bwc_4: Bit rate per client 4 at which transmission does not stop
			nrh264size_4	nrh264size_4: H.264 resolution 4 at which transmission does not stop
			nrh264qual_4	nrh264qual_4: H.264 image quality 4 at which transmission does not stop
			h264fpriority	h264fpriority: H.264(1) transmission mode

CGI item name	URL	Parameter name	Parameter value	Description
			h264nrframerate	h264nrframerate: H.264(1) frame rate
			h264fpriority_2	h264fpriority_2: H.264(2) transmission mode
			h264nrframerate_2	h264nrframerate_2: H.264(2) frame rate
			h264fpriority_3	h264fpriority_3: H.264(3) transmission mode
			h264nrframerate_3	h264nrframerate_3: H.264(3) frame rate
			h264fpriority_4	h264fpriority_4: H.264(4) transmission mode
			h264nrframerate_4	h264nrframerate_4: H.264(4) frame rate
			h264bwcmmin_2	H.264(2) Bit rate per client (minimum)
			h264bwcmmin_3	H.264(3) Bit rate per client (minimum)
			h264bwcmmin_4	H.264(4) Bit rate per client (minimum)
			livequalbase	JPEG default image quality
			liveframerate	Live screen initial frame rate (JPEG)
			plugin_half_tone_jpeg	Enabling/disabling of half-tone function for JPEG images in Active X
			plugin_half_tone_h264	Enabling/disabling of half-tone function for H.264 movies in Active X
		(None)	-	If there is no parameter specification, issue the list of setting data in a batch, as the response.

For details, see "Acquiring the List of Setting Values".

## 6. CGI List for HTTPS Control

### 6.1. Setting Information and Acquiring Certification

Method : GET

Access level : Admin

CGI item name	URL	Parameter name	Parameter value	Description
HTTPS self-signed certificate	https_self_signed	mode	get_info delete	get_info: Information confirmation delete: Delete
HTTPS CA certificate	https_signed	mode	get_info delete	get_info: Information confirmation delete: Delete
HTTPS CRT key history usage	https_crt_key	mode	refresh	Processing of CRT key refresh: Update
HTTPS connection method	set_https	live	http https	http: HTTP https: HTTPS
		https_port	1 to 65535	HTTPS port number
HTTPS self-signed certificate generate	https_creat_self_signed	common_name	String	Host name
		country	String	Country name
		state	String	Prefecture name
		locality	String	Locality name
		organization	String	Organization name
		organization_unit	String	Department name
HTTPS CSR generate	https_creat_signed	common_name	String	Host name
		country	String	Country name
		state	String	Prefecture name
		locality	String	Locality name
		organization	String	Organization name
		organization_unit	String	Department name
HTTPS CSR download	/cgi-bin/https_download_csr			
HTTPS CA certificate install	https_install_signed	-	-	-
HTTPS CRT key generate	https_change_crt_key	rsa_length	1024 2048	1024: 1024 bit 2048: 2048 bit

CGI item name	URL	Parameter name	Parameter value	Description
Status update	renewal	cgi_name	self_create csr_create ca_install key_create	self_create: Self-signed certificate creation status csr_create: CSR creation status ca_install: CA certificate installation status key_create: CRT key generation status

## 6.2. Information Acquisition

Method : GET

Access level : Live

CGI item name	URL	Parameter name	Parameter value	Description
HTTPS settings information acquisition	/cgi-bin/get_https			
HTTPS CRT key information acquisition	/cgi-bin/get crt_key			

It is recommended to implement the HTTPS settings through GUI from the WEB menu. Some models may not have the HTTPS function.

## 7. CGI List for FTP Control

### 7.1. FTP Server Settings

Method : POST

Access level : Admin

CGI item name	URL	Parameter name	Parameter value	Description
FTP server settings	/cgi-bin/set_ftp	server_addr	*.*.* format, string *.*.*.*.* format	*.*.* format, string *.*.*.*.* format (within 128 single-byte alphanumeric characters)
		username	String	String (within 32 single-byte alphanumeric characters)
		password	String	String (within 32 single-byte alphanumeric characters)
		port_num	1 to 65535	1 to 65535
		mode	active passive	active: Active mode passive: Passive mode
		dirname	String	Folder name created in the root directory of the user after logging in to the FTP server (String (within 256 characters)) * Characters that can be entered: Double-byte, single-byte symbols (", &, :)

Usage example) Set the FTP server "192.168.0.1". Set the ID/PASS of the FTP server as user1/password, and the folder as user1.

[http://192.168.0.10/cgi-bin/set\\_ftp?server\\_addr=192.168.0.1&username=user1&password=password&port\\_num=100&mode=active&dirname=dir](http://192.168.0.10/cgi-bin/set_ftp?server_addr=192.168.0.1&username=user1&password=password&port_num=100&mode=active&dirname=dir)

## 7.2. FTP Server Transfer Instruction

Method : POST/GET

Access level : Admin

CGI item name	URL	Parameter name	Parameter value	Description
Transfer to FTP server	/cgi-bin/send_ftpserver	fileno	Numeric value	File No. acquired by /cgi-bin/get_mp4_list2  * Up to 50 file numbers can be specified When specifying multiple files, separate the File No. with a ",".
		select_type	fileno all	fileno: File No. all: Specify all  * When "all" is specified, do not specify the File No. to be transferred.
		list_id	Numeric value	List ID acquired by /cgi-bin/get_mp4_list2
Cancellation of transfer to FTP server	/cgi-bin/cancel_send_ftpserver			

Usage example) Transfer File No. 1 by specifying the file no.

[http://192.168.0.10/cgi-bin/send\\_ftpserver?fileno=1&select\\_type=fileno&list\\_id=100](http://192.168.0.10/cgi-bin/send_ftpserver?fileno=1&select_type=fileno&list_id=100)

Usage example) Transfer File No. 1 and No. 3 by specifying the file no.

[http://192.168.0.10/cgi-bin/send\\_ftpserver?fileno=2,3&select\\_type=fileno&list\\_id=100](http://192.168.0.10/cgi-bin/send_ftpserver?fileno=2,3&select_type=fileno&list_id=100)

Usage example) Transfer all files

[http://192.168.0.10/cgi-bin/send\\_ftpserver?select\\_type=all&list\\_id=100](http://192.168.0.10/cgi-bin/send_ftpserver?select_type=all&list_id=100)

Usage example) Cancel transfer

[http://192.168.0.10/cgi-bin/cancel\\_send\\_ftpserver](http://192.168.0.10/cgi-bin/cancel_send_ftpserver)



### 7.3. FTP Server Information Acquisition

Method : GET  
Access level : Admin

CGI item name	URL	Parameter name	Parameter value	Description
FTP server settings information acquisition	/cgi-bin/get_ftp			

The response data is as shown below.

server\_addr = \*.\*.\* format/\*.\*.\*.\*.\*.\* format  
dirname = String  
username = String  
port\_num = Numeric value  
mode = active/passive

### 7.4. FTP Server Progress Confirmation

Method : GET  
Access level : Admin

CGI item name	URL	Parameter name	Parameter value	Description
Progress confirmation	/cgi-bin/get_progress	type	send_ftp	Acquisition of progress of FTP server transfer

The response data is as shown below.

progress = xxx  
rate = Numeric value (%)

\* Value to be entered in xxx  
prepare: Preparation in progress  
exec: Processing in progress  
finish: Completed  
cancel: Cancellation in progress  
error: Termination with an error  
\* "rate" indicates the rate of progress.

## 7.5. FTP Control Sequence

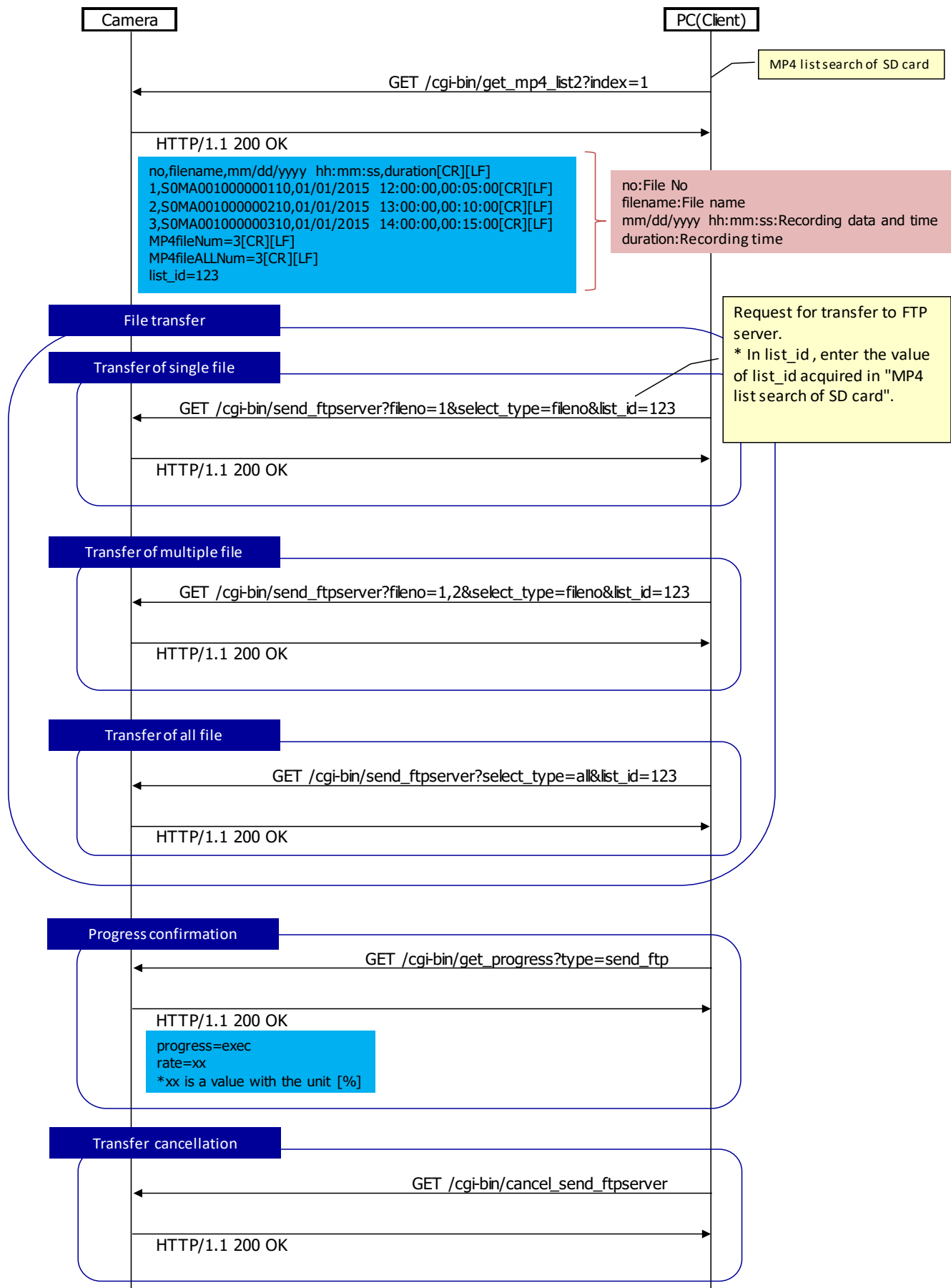

## 7.6. About Folder Settings at the FTP Server Side

In the remote camera, a predetermined folder is created inside the transfer-destination FTP server each time a transfer start command (/cgi-bin/send\_ftpserver) is issued to the FTP server, and the MP4 files within the SD card are transferred.

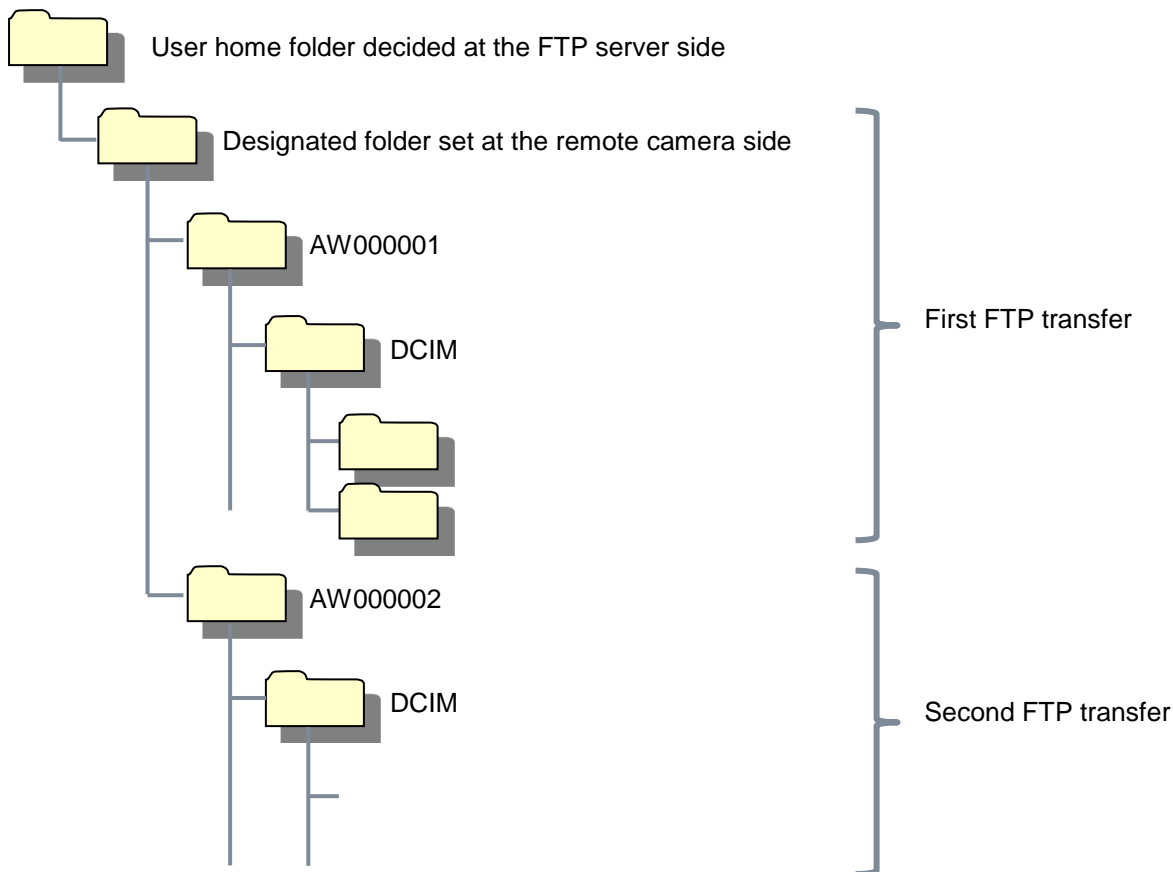

If the designated folder (dirname according to FTP server settings) to be set at the remote camera side does not exist at the FTP server side, the remote camera automatically creates a new folder when transfer starts\*\*. In addition, a sequence number folder starting with "AW" is created under the designated folder, and an SD card folder image starting with DCIM is transferred to the folder.

If a sequence number folder starting with "AW" exists at the time of start of transfer, a new folder with the numeric value incremented by one is created automatically.

Note that if the AW999999 folder exists, FTP transfer cannot be started.

\*\*note

If FTP transfer fails, the designated folder (dirname in FTP server settings) to be set on the remote camera side may not exist. We recommend creating the folder in advance on the FTP server side.

## 8. CGI List for Recording/Playback Control on SD Card

### 8.1. Video Recording Mode Settings

Method : POST

Access level : Admin

CGI item name	URL	Parameter name	Parameter value	Description
SD card recording mode settings	/cgi-bin/set_sdrec_mode	mode	1080_60p_28m	1080_60p_28m: 1920x1080/60p 28Mbps
			1080_30p_15m	1080_30p_15m: 1920x1080/30p 15Mbps
			1080_30p_10m	1080_30p_10m: 1920x1080/30p 10Mbps
			1080_30p_6m	1080_30p_6m: 1920x1080/30p 6Mbps
			720_60p_15m	720_60p_15m: 1280x720/60p 15Mbps
			720_30p_8m	720_30p_8m: 1280x720/30p 8Mbps
			720_30p_4m	720_30p_4m: 1280x720/30p 4Mbps
			720_30p_2m	720_30p_2m: 1280x720/30p 2Mbps
			1080_50p_28m	1080_50p_28m: 1920x1080/50p 28Mbps
			1080_25p_15m	1080_25p_15m: 1920x1080/25p 15Mbps
			1080_25p_10m	1080_25p_10m: 1920x1080/25p 10Mbps
			1080_25p_6m	1080_25p_6m: 1920x1080/25p 6Mbps
			720_50p_15m	720_50p_15m: 1280x720/50p 15Mbps
			720_25p_8m	720_25p_8m: 1280x720/25p 8Mbps
			720_25p_4m	720_25p_4m: 1280x720/25p 4Mbps
			720_25p_2m	720_25p_2m: 1280x720/25p 2Mbps
		2160_25p_72m(*1)	2160_25p_72m: 3840x2160/25p 72Mbps	
			(*1): Only for UE70 series	
REC link tally settings	/cgi-bin/set_rectally	enable	true false	true: Linking ON false: Linking OFF

Usage example) Set to 1080/30p\_15 Mbps

[http://192.168.0.10/cgi-bin/set\\_sdrec\\_mode?mode=1080\\_30p\\_15m](http://192.168.0.10/cgi-bin/set_sdrec_mode?mode=1080_30p_15m)

## 8.2. Video Recording Mode Acquisition

Method : GET

Access level : Live

CGI item name	URL	Parameter name	Parameter value	Description
SD card recording mode acquisition	/cgi-bin/get_sdrec_mode			
REC link tally settings acquisition	/cgi-bin/get_rectally			

The response data is as shown below.

sdrec\_mode = xxx

\* For details on the value notified by xxx, see the parameters of /cgi-bin/set\_sdrec\_mode.

## 8.3. Video Recording Start/End Control

Method : GET

Access level : Live

CGI item name	URL	Parameter name	Parameter value	Description
MP4 recording to SD card	/cgi-bin/sdctrl	save	start end	start: Recording start end: Recording end

Usage example) Start MP4 recording to the SD card.

<http://192.168.0.10/cgi-bin/sdctrl?save=start>

Usage example) End MP4 recording to the SD card.

<http://192.168.0.10/cgi-bin/sdctrl?save=end>

\* Both recording start and recording end require a few seconds as processing time.

Secure some interval time during operation.

## 8.4. SD Card Format (Initialization) Control

Method : POST

Access level : Admin

CGI item name	URL	Parameter name	Parameter value	Description
SD card format	/cgi-bin/sdcard	cmd	format	Formatting of SD memory card

Usage example) Start formatting (initialization) of SD card

<http://192.168.0.10/cgi-bin/sdcard?cmd=format>

- \* If you perform formatting during the use of the SD card, "ErrorNo=3" is returned in the main text. You cannot perform formatting in such a case.
- \* Depending on the type and state of the card, formatting (initialization) of the SD card may be performed after complete erasure of the SD card. In such a case, a maximum of approx. 120 seconds are needed as the processing time./ Issue the next command after confirming completion of formatting with [cgi-bin/get\\_progress](#).

## 8.5. SD Card Format (Initialization) Progress Confirmation

Method : GET

Access level : Admin

CGI item name	URL	Parameter name	Parameter value	Description
Progress confirmation	/cgi-bin/get_progress	type	format	Acquisition of formatting progress of SD memory card

The response data is as shown below.

progress = xxx

- \* Value to be entered in xxx
  - prepare: Preparation in progress
  - exec: Processing in progress
  - finish: Completed
  - cancel: Cancellation in progress
  - error: Termination with an error

## 8.6. MP4 File List Search

Method : GET

Access level : Live

CGI item name	URL	Parameter name	Parameter value	Description
MP4 list search of SD card	/cgi-bin/get_mp4_list2	maxmatches	1 to 15	Upper-limit of number of lists to be acquired * Can be omitted
		index	Numeric value	List search start position 1 to 65535

Usage example) Acquire list from No. 1 with 10 as the upper-limit number.

[http://192.168.0.10/cgi-bin/get\\_mp4\\_list2?maxmatches=10&index=1](http://192.168.0.10/cgi-bin/get_mp4_list2?maxmatches=10&index=1)

The response data is as shown below.

no,filename,mm/dd/yyyy hh:mm:ss,duration[CR][LF]

▪  
▪  
▪

MP4fileNum = Numeric value (acquired number of lists) [CR][LF]

MP4fileALLNum = Numeric value (total number of files) [CR][LF]

list\_id = Numeric value

The response data example is as shown below.

no,filename,mm/dd/yyyy hh:mm:ss,duration[CR][LF]

1,S0MA001000000110,01/01/2015 12:0:0,00:05:05[CR][LF]

2,S0MA001000000210,01/01/2015 15:15:15,00:05:05[CR][LF]

MP4fileNum=2[CR][LF]

MP4fileALLNum=2[CR][LF]

list\_id=123

Note that mm/dd/yyyy hh:mm:ss and duration indicate the recording start date and time and recording elapsed time of the corresponding MP4 file.

list\_id on the last line is a unique value for the acquired file list. It is used for deletion, download, and FTP transfer.

## 8.7. MP4 File Playback Control

Method : GET

Access level : Live

CGI item name	URL	Parameter name	Parameter value	Description
Selection of playback data	/cgi-bin/set_playscene_mp4	filename	String	File name acquired by /cgi-bin/get_mp4_list2
		list_id	Numeric value	List ID acquired by /cgi-bin/get_mp4_list2
Playback of stored data	/cgi-bin/playcmd_mp4	type	start stop pause restart	start: Playback from the start position stop: Playback stopped pause: Playback paused restart: Playback resumed
		restart_msec	Numeric value	Number of seconds (msec) from the start position * Specified when type = restart
		list_id	Numeric value	List ID acquired by /cgi-bin/get_mp4_list2

Usage example) Select 000120150101

[http://192.168.0.10/cgi-bin/set\\_playscene\\_mp4?filename=SOMA001000000110&list\\_id=123](http://192.168.0.10/cgi-bin/set_playscene_mp4?filename=SOMA001000000110&list_id=123)

Usage example) Start playback of the selected file

[http://192.168.0.10/cgi-bin/playcmd\\_mp4?type=start&list\\_id=123](http://192.168.0.10/cgi-bin/playcmd_mp4?type=start&list_id=123)

\* If you perform playback during the use of the SD card, "ErrorNo=3" is returned in the main text. You cannot perform playback in such a case.

\* The playback video is converted to JPEG format and transmitted. Use /cgi-bin/view\_pb.cgi for acquisition of video.



## 8.8. MP4 File Playback Sequence

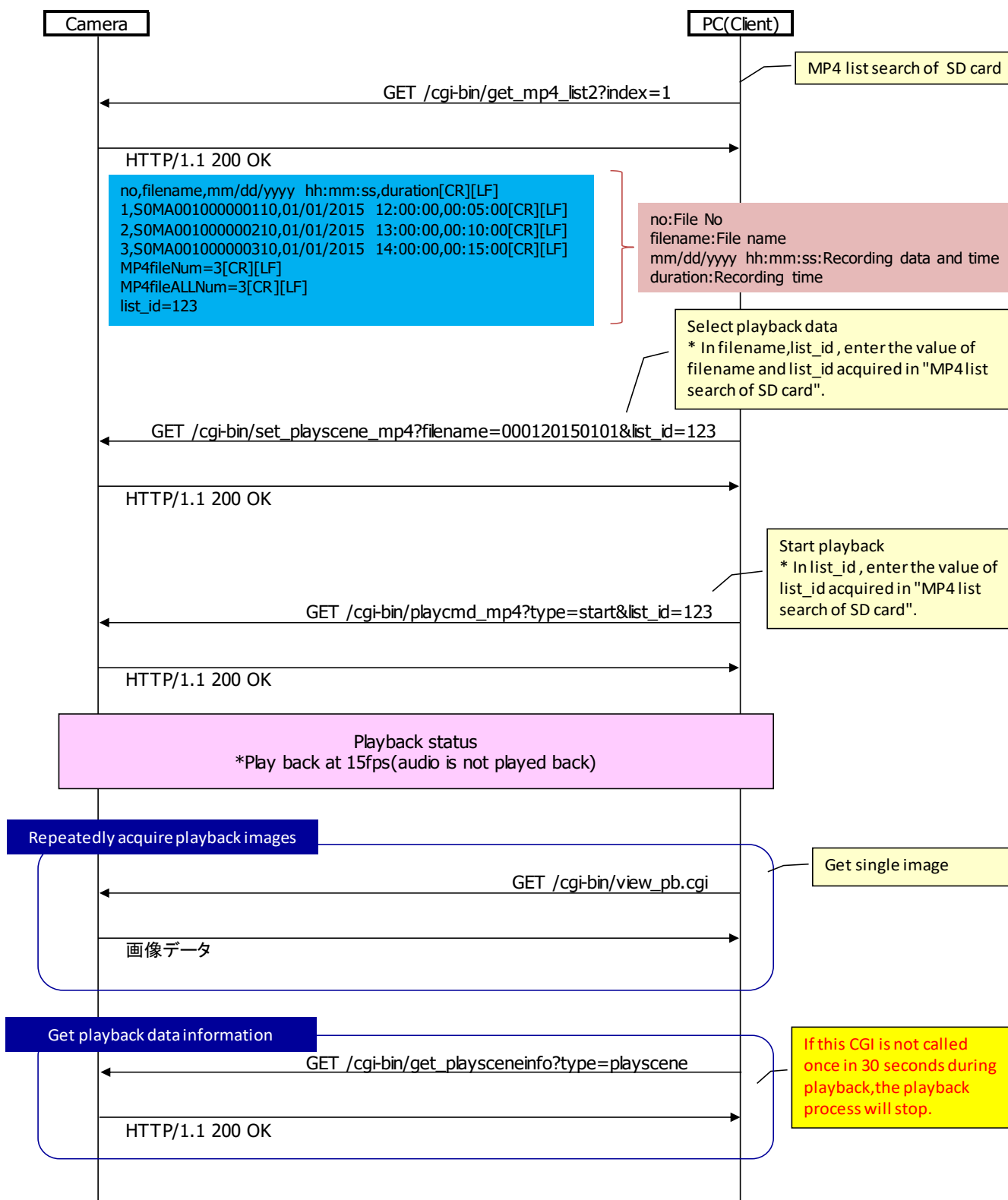

## 8.9. MP4 File Deletion

Method : GET

Access level : Live

CGI item name	URL	Parameter name	Parameter value	Description
Deletion of stored data	/cgi-bin/del_mp4_file	fileno	Numeric value	File No. acquired by /cgi-bin/get_mp4_list2 * A max. of up to 50 files can be specified.
		list_id	Numeric value	List ID acquired by /cgi-bin/get_mp4_list2

Usage example) Delete file no. 1 and 2

[http://192.168.0.10/cgi-bin/del\\_mp4\\_file?fileno=1,2&list\\_id=123](http://192.168.0.10/cgi-bin/del_mp4_file?fileno=1,2&list_id=123)

## 8.10. Acquiring Information of MP4 File being Played Back

Method : GET

Access level : Live

CGI item name	URL	Parameter name	Parameter value	Description
Playback data information acquisition	/cgi-bin/get_play_sceneinfo	type	playscene setscene	playscene: Information about content being played back setscene: Information about set content  * Can be omitted ▪ If the "type" has not been specified, assume type = playscene. ▪ If this CGI is not called once in 30 seconds during playback, the playback process will stop.

The response data is as shown below.

playtype = play/stop/pause

filename = String

startpts = Numeric value

endpts = Numeric value

curtime = Numeric value (time period [msec] from start)

duration = hh:mm:ss

time = mm/dd/yyyy hh:mm:ss

sdrec\_mode = String (same as "value" of /cgi-bin/set\_sdrec\_mode)

## 8.11. MP4 File Download Control

Method : GET

Access level : Live

CGI item name	URL	Parameter name	Parameter value	Description
Download through file specification	/cgi-bin/get_mp4_file	filename	String	File name acquired by /cgi-bin/get_mp4_list2
		list_id	Numeric value	List ID acquired by /cgi-bin/get_mp4_list2

Usage example) Download the file 000120150101.

[http://192.168.0.10/cgi-bin/get\\_mp4\\_file?filename=SOMA001000000110&list\\_id=123](http://192.168.0.10/cgi-bin/get_mp4_file?filename=SOMA001000000110&list_id=123)

## 8.12. MP4 File Download Sequence

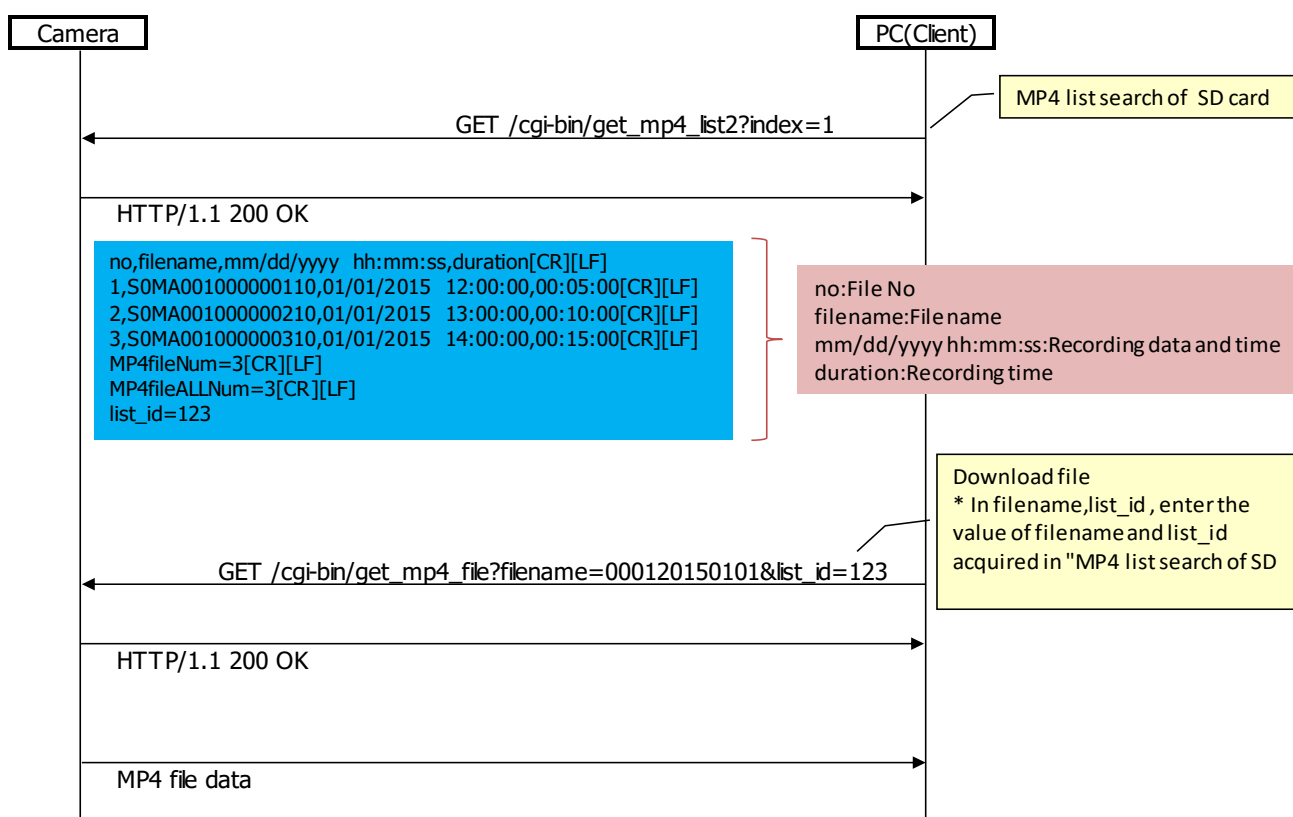

During download, the remote camera issues a response by assuming the file name acquired by /cgi-bin/get\_mp4\_list2 (ex. SOMA001000000110.mp4) as the default file name. After completion of download, it is recommended to rename to the date acquired by /cgi-bin/get\_mp4\_list2.

## 8.13. Still picture image save

\*\* Both HE 40 / UE 70 series require Ver. 1.8 or later.

Method :GET

Access level :Live

CGI item name	URL	Parameter name	Parameter value	Description
Still picture image Control	/cgi-bin/image	action	save	save: Still picture image save
		fileno	Numeric value	Action target still picture image file number. XX of "S10000XX.JPG"(1~99)
		output	off on	Still picture image data response after save (Optional, off by default)

Usage example) Save to S1000001.JPG file

<http://192.168.0.10/cgi-bin/image?action=save&fileno=1>

The response data is as shown below.

"Image Save OK"	Still picture image save is success (output = off)
... (JPEG) ...	Still picture image save is success (output = on)
"Image Bad Request"	Bad Request
"Image Internal Server Error"	Standby state or JPEG transfer disabled state
"Check Media"	Media factor error (no card, card error)
"Media Busy"	Status error (Can not operate due to media access etc.)
"Image Save Error"	Other error

The resolution / picture quality of the still picture to be saved conforms to the setting contents of JPEG (1) of WEB menu / Video over IP / JPEG. When JPEG (1) is off, it conforms to the setting contents of JPEG (2) or JPEG (3).

The recording destinations inside the SD card are as follows.

PRIVATE/100CDPFQ/S10000XX.JPG

XX= fileno

The saved still picture image is not transferred by the FTP transfer function of chapter 7.

## 8.14. Still picture image load / delete / find

\*\* Both HE 40 / UE 70 series require Ver. 1.8 or later.

Method : GET

Access level : Live

CGI item name	URL	Parameter name	Parameter value	Description
Still picture image Control	/cgi-bin/image	action	load delete find	load: Still picture image load delete: Still picture image delete find: Still picture image find
		fileno	Numeric value	Action target still picture image file number. XX of "S10000XX.JPG"(1~99)

Usage example) load S1000001.JPG file

<http://192.168.0.10/cgi-bin/image?action=load&fileno=1>

The response data is as shown below.

...(JPEG)...	Still picture image load is success
"Image Find NG"	The file with the specified number does not exist
"Image Load Error"	Other error

Usage example) delete S1000001.JPG file

<http://192.168.0.10/cgi-bin/image?action=delete&fileno=1>

The response data is as shown below.

"Image Delete OK"	Still picture image delete is success
"Image Find NG"	The file with the specified number does not exist
"Image Delete Error"	Other error

Usage example) find S1000001.JPG file

<http://192.168.0.10/cgi-bin/image?action=find&fileno=1>

The response data is as shown below.

"Image Find OK"	The file with the specified number exists
"Image Find NG"	The file with the specified number does not exist

The Common error response data is as shown below.

"Image Bad Request"	Bad Request
"Image Internal Server Error"	Standby state or JPEG transfer disabled state
"Check Media"	Media factor error (no card, card error)
"Media Busy"	Status error (Can not operate due to media access etc.)

## 9. Acquiring the List of Setting Values

Method : GET

Access level : Live

CGI item name	URL	Parameter name	Parameter value	Description
Acquisition of list of setting values	/cgi-bin/setdata			Parameters are not required.

The response data is as shown below.

CAMTITLE,"AW-HE70"  
IMAGESELECT,"2m"  
IMAGERATIO,"16\_9"  
IMAGEFPS,"30"  
LIVESTREAM,"h264\_4"  
LIVEINT,"30"  
LIVEQUALBASE,"1"  
LIVESIZE,"640"  
LIVEQUAL,"5"  
LIVESIZE2,"1280"  
LIVEQUAL2,"5"  
LIVESIZE3,"320"  
LIVEQUAL3,"5"  
STREAMMODE,"1"  
H264,"1"  
H264RTSPMODE,"0"  
H264BWC,"8192"  
NRH264BWC,"1024"  
H264BWCMIN,"6144"  
H264SIZE,"1280"  
NRH264SIZE,"1280"  
H264FPRIORITY,"2"  
H264NRFRAMERATE,"30"  
H264QUAL,"fine"  
NRH264QUAL,"normal"  
H264RINT,"1"  
H264MTD,"multi"  
H264MLADD1,"239"  
H264MLADD2,"192"  
H264MLADD3,"0"  
H264MLADD4,"20"  
H264MLADD,"239.192.0.20"  
H264MLPORT,"37004"  
H264MLTTL,"16"  
H264UNIPORT,"32004"

H264UNIPORT2,"33004"  
H264PROFILE,"0"  
H264\_2,"1"  
H264RTSPMODE\_2,"0"  
H264BWC\_2,"8192"  
NRH264BWC\_2,"1024"  
H264BWCMIN\_2,"4096"  
H264SIZE\_2,"1280"  
NRH264SIZE\_2,"640"  
H264FPRIORITY\_2,"1"  
H264NRFRAMERATE\_2,"30"  
H264QUAL\_2,"low"  
NRH264QUAL\_2,"normal"  
H264RINT\_2,"1"  
H264MTD\_2,"uni"  
H264MLADD1\_2,"239"  
H264MLADD2\_2,"192"  
H264MLADD3\_2,"0"  
H264MLADD4\_2,"21"  
H264MLADD\_2,"239.192.0.21"  
H264MLPORT\_2,"37004"  
H264MLTTL\_2,"16"  
H264UNIPORT\_2,"32014"  
H264UNIPORT2\_2,"33014"  
H264PROFILE\_2,"0"  
H264\_3,"1"  
H264RTSPMODE\_3,"0"  
H264BWC\_3,"4096"  
NRH264BWC\_3,"1024"  
H264BWCMIN\_3,"1024"  
H264SIZE\_3,"640"  
NRH264SIZE\_3,"640"  
H264FPRIORITY\_3,"1"  
H264NRFRAMERATE\_3,"30"  
H264QUAL\_3,"low"  
NRH264QUAL\_3,"normal"  
H264RINT\_3,"1"  
H264MTD\_3,"uni"  
H264MLADD1\_3,"-"  
H264MLADD2\_3,"-"  
H264MLADD3\_3,"-"  
H264MLADD4\_3,"-"  
H264MLADD\_3,"ff02::1"  
H264MLPORT\_3,"37004"  
H264MLTTL\_3,"16"  
H264UNIPORT\_3,"32024"  
H264UNIPORT2\_3,"33024"  
H264PROFILE\_3,"0"

H264\_4,"1"  
 H264RTSPMODE\_4,"1"  
 H264BWC\_4,"1536"  
 NRH264BWC\_4,"1024"  
 H264BWCMIN\_4,"512"  
 H264SIZE\_4,"320"  
 NRH264SIZE\_4,"640"  
 H264FPRIORITY\_4,"0"  
 H264NRFRAMERATE\_4,"30"  
 H264QUAL\_4,"low"  
 NRH264QUAL\_4,"normal"  
 H264RINT\_4,"1"  
 H264MTD\_4,"uni"  
 H264MLADD1\_4,"239"  
 H264MLADD2\_4,"192"  
 H264MLADD3\_4,"0"  
 H264MLADD4\_4,"23"  
 H264MLADD\_4,"239.192.0.23"  
 H264MLPORT\_4,"37004"  
 H264MLTTL\_4,"16"  
 H264UNIPORT\_4,"32034"  
 H264UNIPORT2\_4,"33034"  
 H264PROFILE\_4,"0"  
 RTSPPORT,"554"  
 H264MLAUTO,"0"  
 H264MLAUTO\_2,"0"  
 H264MLAUTO\_3,"0"  
 H264MLAUTO\_4,"0"  
 AUDIO,"in"  
 AUDIOSENS,"line\_middle"  
 AUDIOBITRATE,"128"  
 AUDIOENC,"2"  
 AUDIOMIC,"internal"  
 PLUGIN\_HALFTONE\_JPEG,"0"  
 PLUGIN\_HALFTONE\_H264,"0"

The description of the response data is as shown below.

Setting name	Value	Description
CAMTITLE	String	Camera name
IMAGESELECT	2m	Imaging mode 2m: 2 M pixel
IMAGERATIO	16_9	Image ratio 16_9: 16:9 mode
IMAGEFPS	30	Frame rate



Setting name	Value	Description
		30: 30 fps
LIVESTREAM	h264 h264_2 h264_3 h264_4 jpeg jpeg_2 jpeg_3	Live screen initial stream selection h264:H264(1) h264_2:H264(2) h264_3:H264(3) h264_4:H264(4) jpeg:JPEG(1) jpeg_2:JPEG(2) jpeg_3:JPEG(3)
LIVEINT	1 5 15(12.5) 30(25)	JPEG(1) refresh interval 1:1fps 5:5fps 15(12.5):15(12.5)fps 30(25):30(25)fps * The values within () are for the case when the system frequency is 50 Hz
LIVEQUALBASE	1	JPEG(1) default image quality 1: Image quality 1
LIVESIZE	320 640 1280 1920	JPEG(1) image resolution 320:320x180 640:640x360 1280:1280x720 1920:1920x1080
LIVESIZE2	320 640 1280	JPEG(2) image resolution 320:320x180 640:640x360 1280:1280x720
LIVESIZE3	320 640 1280	JPEG(3) image resolution 320:320x180 640:640x360 1280:1280x720
LIVEQUAL	1 5	JPEG(1) image quality 1: Fine 5: Normal
LIVEQUAL2	1 5	JPEG(2) image quality 1: Fine 5: Normal
LIVEQUAL3	1 5	JPEG(3) image quality 1: Fine 5: Normal
STREAMMODE	1	Movie transmission method 1: H264
H264	0	H264 transmission ON/OFF 0: OFF 1: ON
H264_2	1	
H264_3		

Setting name	Value	Description
H264_4		
H264RTSPMODE	0	Internet mode ON/OFF
H264RTSPMODE_2	1	0: OFF
H264RTSPMODE_3		1: ON
H264RTSPMODE_4		
H264BWC	512,768,1024,1536, 2048,3072,4096,6144,	Bit rate per client 512 (kbps)
H264BWC_2	8192,10240,12288, 14336,16384,20480,	~ 24576 (kbps)
H264BWC_3	24576, 32768(*1),	~ 51200 (kbps)
H264BWC_4	40960(*1), 51200(*1)	(*1): Only for UE70 series
H264BWCMIN	512,768,1024,1536, 2048,3072,4096,6144,	Minimum bit rate per client 512 (kbps)
H264BWCMIN_2	8192,10240,12288, 14336,16384,20480,	~ 24576 (kbps)
H264BWCMIN_3	24576, 32768(*1),	~ 51200 (kbps)
H264BWCMIN_4	40960(*1), 51200(*1)	(*1): Only for UE70 series
NRH264BWC	Numeric value	Bit rate per client at which transmission does not stop Unit [kbps]
NRH264BWC_2		* The value acquired by setdata depends on the minimum bit rate per client.
NRH264BWC_3		
NRH264BWC_4		
H264SIZE	320 640 1280 1920 3840(*1)	H264(1) resolution 320:320x180 640:640x360 1280:1280x720 1920:1920x1080 (*1): Only for UE70 series
H264SIZE_2	320 640 1280	H264(2) resolution 320:320x180 640:640x360 1280:1280x720
H264SIZE_3	320 640 1280	H264(3) resolution 320:320x180 640:640x360 1280:1280x720
H264SIZE_4	320 640 1280	H264(4) resolution 320:320x180 640:640x360 1280:1280x720

Setting name	Value	Description
NRH264SIZE	320 640 1280 1920 3840(*1)	H264(1) resolution at which transmission does not stop 320:320x180 640:640x360 1280:1280x720 1920:1920x1080 3840: 3840x2160 (*1) (*1): Only for UE70 series The value acquired by setdata depends on the value of H264(1).
NRH264SIZE_2	320 640 1280	H264(2) resolution at which transmission does not stop 320:320x180 640:640x360 1280:1280x720 The value acquired by setdata depends on the value of H264(2).
NRH264SIZE_3	320 640 1280	H264(3) resolution at which transmission does not stop 320:320x180 640:640x360 1280:1280x720 The value acquired by setdata depends on the value of H264(3).
NRH264SIZE_4	320 640 1280	H264(4) resolution at which transmission does not stop 320:320x180 640:640x360 1280:1280x720 The value acquired by setdata depends on the value of H264(4).
H264FPRIORITY	0	Transmission mode
H264FPRIORITY_2	1	0:Constant bit rate
H264FPRIORITY_3	2	1:Frame rate
H264FPRIORITY_4		2:Best effort
H264NRFRAMERATE	5 15(12.5) 30(25) 60(50)	H264(1) frame rate 5:5fps 15(12.5):15(12.5)fps 30(25):30(25)fps 60(50):60(50)fps * The values within () are for the case when the system frequency is 50 Hz
H264NRFRAMERATE_2	5 15(12.5) 30(25)	H264(2) frame rate 5:5fps 15(12.5):15(12.5)fps 30(25):30(25)fps

Setting name	Value	Description
		* The values within () are for the case when the system frequency is 50 Hz
H264NRFRAMERATE_3	5 15(12.5) 30(25)	H264(3) frame rate 5:5fps 15(12.5):15(12.5)fps 30(25):30(25)fps * The values within () are for the case when the system frequency is 50 Hz
H264NRFRAMERATE_4	5 15(12.5) 30(25)	H264(4) frame rate 5:5fps 15(12.5):15(12.5)fps 30(25):30(25)fps * The values within () are for the case when the system frequency is 50 Hz
H264QUAL	fine	H264 image quality fine: Image quality priority low: Motion priority
H264QUAL_2	low	
H264QUAL_3		
H264QUAL_4		
NRH264QUAL	normal	H264 image quality at which transmission does not stop normal: Standard
NRH264QUAL_2		
NRH264QUAL_3		
NRH264QUAL_4		
H264RINT	1	Refresh cycle 1: 1 second
H264RINT_2		
H264RINT_3		
H264RINT_4		
H264MTD	uni	H264 transmission method uni:Unicast port(AUTO) uni_manual:Unicast port(MANUAL) multi:Multicast
H264MTD_2	uni_manual	
H264MTD_3	multi	
H264MTD_4		
H264MLADD1	Numeric value	H264(1) multicast address First octet 224 to 239
H264MLADD2	Numeric value	H264(1) multicast address Second octet 0 to 255
H264MLADD3	Numeric value	H264(1) multicast address Third octet 0 to 255
H264MLADD4	Numeric value	H264(1) multicast address Fourth octet 0 to 255
H264MLADD1_2	Numeric value	H264(2) multicast address First octet 224 to 239
H264MLADD2_2	Numeric value	H264(2) multicast address Second octet 0 to 255
H264MLADD3_2	Numeric value	H264(2) multicast address Third octet

Setting name	Value	Description
		0 to 255
H264MLADD4_2	Numeric value	H264(2) multicast address Fourth octet 0 to 255
H264MLADD1_3	Numeric value	H264(3) multicast address First octet 224 to 239
H264MLADD2_3	Numeric value	H264(3) multicast address Second octet 0 to 255
H264MLADD3_3	Numeric value	H264(3) multicast address Third octet 0 to 255
H264MLADD4_3	Numeric value	H264(3) multicast address Fourth octet 0 to 255
H264MLADD1_4	Numeric value	H264(4) multicast address First octet 224 to 239
H264MLADD2_4	Numeric value	H264(4) multicast address Second octet 0 to 255
H264MLADD3_4	Numeric value	H264(4) multicast address Third octet 0 to 255
H264MLADD4_4	Numeric value	H264(4) multicast address Fourth octet 0 to 255
H264MLADD	(IPv4 address)	H264 multicast address
H264MLADD_2	or	
H264MLADD_3	(IPv6 address)	
H264MLADD_4		
H264MLPORT	Numeric value	H264 multicast port 1024 to 50000
H264MLPORT_2		
H264MLPORT_3		
H264MLPORT_4		
H264MLTTL	Numeric value	H264 multicast TTL 1 to 254
H264MLTTL_2		
H264MLTTL_3		
H264MLTTL_4		
H264UNIPORT	Numeric value	H264 unicast (for video) port number 1024 to 50000 (only even numbers)
H264UNIPORT_2		
H264UNIPORT_3		
H264UNIPORT_4		
H264UNIPORT2	Numeric value	H264 unicast (for audio) port number 1024 to 50000 (only even numbers)
H264UNIPORT2_2		
H264UNIPORT2_3		
H264UNIPORT2_4		
H264PROFILE	0	H264 profile 0: High profile
H264PROFILE_2		
H264PROFILE_3		
H264PROFILE_4		
RTSPPORT	Numeric value	RTSP server port number

Setting name	Value	Description
H264MLAUTO	0	Multicast delivery is started automatically. 0: OFF
H264MLAUTO_2		
H264MLAUTO_3		
H264MLAUTO_4		
AUDIO	in off	Audio settings in: ON off: OFF
AUDIOSENS	low middle high line_low line_middle line_high	Sound collection sensitivity low: Mic Low middle: Mic Middle high: Mic High line_low: Line Low line_middle: Line Middle line_high: Line High
AUDIOBITRATE	64 96 128	Audio bit rate 64: 64 Kbps 96: 96 Kbps 128: 128 Kbps
AUDIOENC	2	Encoder settings 2: AAC
PLUGIN_HALFTONE_JPEG	0	Enabling/disabling of half-tone function for JPEG images in Active X 0: Disabled
PLUGIN_HALFTONE_H264	0	Enabling/disabling of half-tone function for H264 in Active X 0: Disabled

## 10. About Control Based on RTSP

The remote camera supports general RTSP protocols as well. This chapter illustrates usage methods based on RTSP. The customer must have knowledge of RTSP/RTP/RTCP when using such usage methods.

### 10.1. About the URLs for an RTSP Request

The URLs for RTSP requests of the remote camera are as described below.

Request URL	Description
rtsp://<cam_ip>/mediainput/h264/stream_1	Videos set in WEB menu H264(1) of the remote camera can be requested.
rtsp://<cam_ip>/mediainput/h264/stream_2	Videos set in WEB menu H264(2) of the remote camera can be requested.
rtsp://<cam_ip>/mediainput/h264/stream_3	Videos set in WEB menu H264(3) of the remote camera can be requested.
rtsp://<cam_ip>/mediainput/h264/stream_4	Videos set in WEB menu H264(4) of the remote camera can be requested.

The RTSP port at the remote camera (RTSP Server) side is set to 554 according to the factory settings. If it is to be changed, use the cgi-bin/set\_rtsp (POST command).

The relationship between "H.264 transmission" and "Audio Transmission" in the WEB menu of the remote camera is as shown below.

		Audio Transmission	
		ON	OFF
H.264 transmission	ON	Both video and audio can be used. * As for DESCRIBE, the SDP information of video + audio is issued as response.	Only video can be used. * As for DESCRIBE, only the SDP information of video is issued as response.
	OFF	Both video and audio cannot be used. * As for SETUP, 503 is issued as response.	

When "Audio Transmission" is ON, the remote camera issues a response by adding Audio information to the DESCRIBE information. If necessary, the audio can be transmitted by issuing the SETUP command. On the contrary, if the SETUP command is not issued, only the video can be transmitted. Moreover, if "Audio" in the WEB menu of the remote camera is "OFF", or nothing is connected to the "Audio IN terminal", it results in silent transmission.

In this manual, the description is provided by assuming that "H.264 transmission" and "Audio Transmission" are in the ON state.

## 10.2. About the rtsp Methods

The RTSP methods supported in the remote camera are as described below.

Supported Method	Description
<b>OPTIONS</b>	Check for the corresponding command
<b>DESCRIBE</b>	Acquisition of session information and Audio support
<b>SETUP</b>	Initialization of the session and mutual exchange of port information
<b>PLAY</b>	Transfer started
<b>PAUSE</b>	Transfer paused * Transmission is stopped, and this method is ignored during multicast.
<b>GET_PARAMETER</b>	Acquisition of session parameter * Operation is performed by assuming Keep Alive.
<b>TEARDOWN</b>	Transfer end/session end

SET\_PARAMETER is not supported. 501 is issued as response.

The timeout based on GET\_PARAMETER is 120 seconds. If Keep Alive from all clients is blocked including during multicast, the remote camera stops transmission.



## 11. About Acquisition of Stream from RTSP

The RTSP communication methods supported in the remote camera are as described below. No matter which method is used, TCP communication (554 is set as the waiting port at the remote camera side) is used during initial negotiation of RTSP.

### 1. UDP Unicast

- Used for transmitting video/audio to a single client in one remote camera.
- Although transmission to multiple clients is also supported, network bandwidth is needed for each connection.

### 2. UDP Multicast

- Used for transmitting video/audio simultaneously to multiple clients in one remote camera.
- The network bandwidth at the camera side does not increase even when transmission is performed to multiple clients.
- A separate router that supports multicast is needed.

### 3. TCP Unicast

- Used for transmitting video/audio to a single client in one remote camera.
- The video and audio data communicated via RTP/UDP can be transmitted via TCP.

## 11.1. UDP Unicast

You must make the settings described below in the WEB menu as preparations at the remote camera side.

- Set H264(X)/Transmission type to Unicast (AUTO).

The port number during transmission of video and audio stream is decided as described below.

- client\_port (receiving port at the client side):

The client explicitly issues a command to the remote camera in an RTSP "SETUP" sequence.

- \* The methods of deciding the port number differ according to the client, and include random settings and dedicated menu.

- server\_port (transmitting port of the remote camera):

The remote camera issues a response to the client through response in the RTSP "SETUP" sequence.

- \* The port number is decided randomly.

Note that if you want to fix the client\_port forcibly, you can do so by making the WEB menu settings described below.

- Set H264(X)/Transmission type to Unicast (MANUAL).
- Set Unicast port (Image)/Unicast port (Audio).

- \* However, in the RTSP "SETUP" sequence, the content instructed explicitly by the client to the remote camera are ignored, and therefore, it is not used normally.

The acquisition method of video and audio stream by the UDP Unicast method is illustrated below.

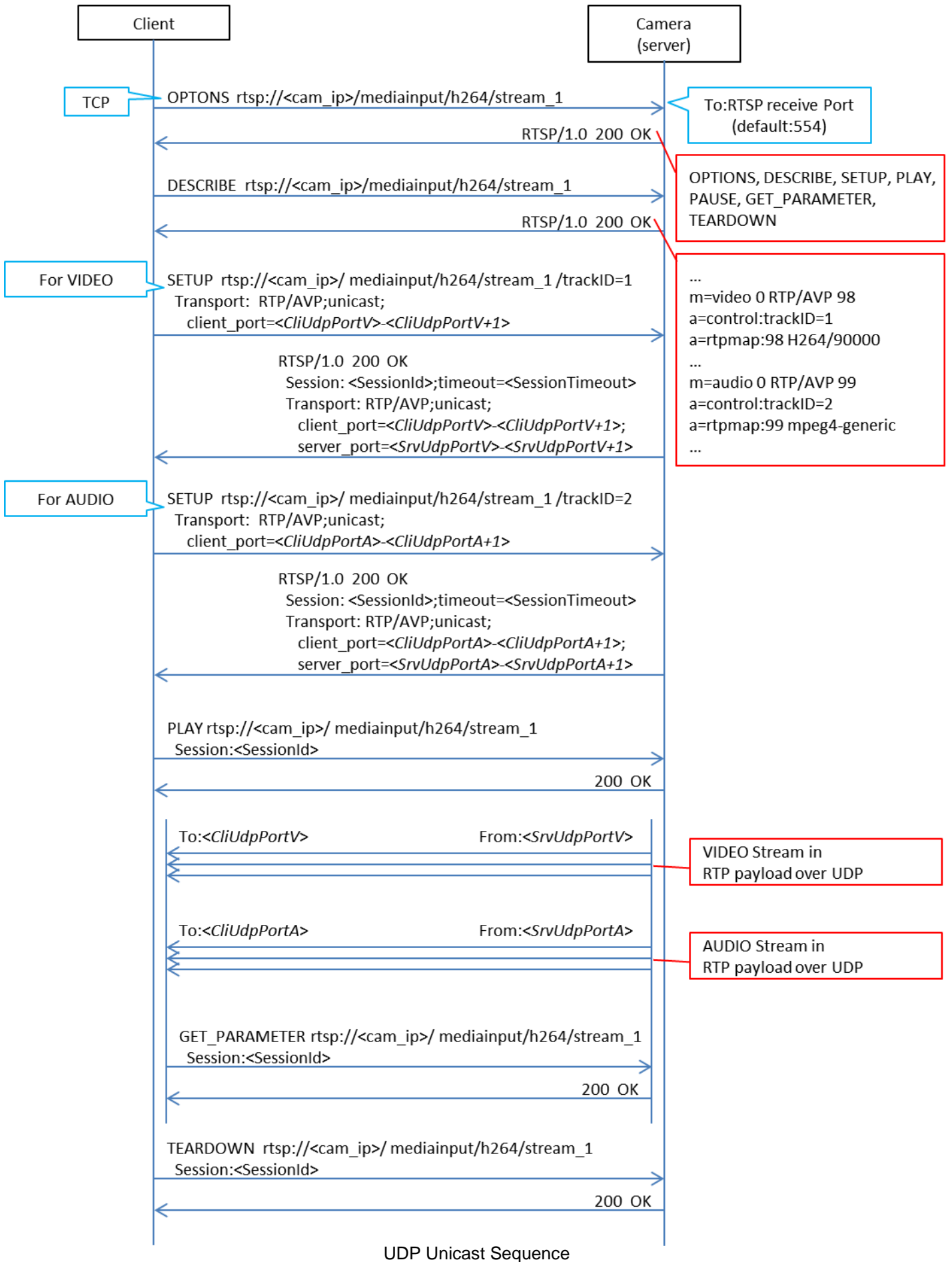

```

OPTIONS rtsp://<cam_ip>/mediainput/h264/stream_1 RTSP/1.0
CSeq: 2
User-Agent: <User-Agent>

RTSP/1.0 200 OK
CSeq: 2
Public: OPTIONS, DESCRIBE, SETUP, PLAY, PAUSE, GET_PARAMETER, TEARDOWN

DESCRIBE rtsp://<cam_ip>/mediainput/h264/stream_1 RTSP/1.0
CSeq: 3
User-Agent: <User-Agent>

RTSP/1.0 200 OK
CSeq: 3
Content-Base: rtsp://<cam_ip>/mediainput/h264/stream_1/
Content-Type: application/sdp
Content-Length: <Length>

v=0
o=- 1 1 IN IP4 <cam_ip>
s=Media Presentation
e=NONE
c=IN IP4 0.0.0.0
b=AS:14464
t=0 0
a=control:*
a=range:npt=now-
m=video 0 RTP/AVP 98
b=AS:14336
a=framerate:30.0
a=control:trackID=1
a=rtpmap:98 H264/90000
a=fmtp:98 packetization-mode=1
a=h264-esid:201
m=audio 0 RTP/AVP 99
a=control:trackID=2
a=rtpmap:99 mpeg4-generic/48000/2
a=fmtp:99 streamType=5; profile-level-id=41; mode=AAC-hbr; config=1190; sizeLength=13; indexLength=3;
indexDeltaLength=3; bitrate=128000
a=h264-esid:101

SETUP rtsp://<cam_ip>/mediainput/h264/stream_1/trackID=1 RTSP/1.0
CSeq: 4
User-Agent: <User-Agent>
Transport: RTP/AVP;unicast;client_port=<CliUdpPortV>-<CliUdpPortV+1>

RTSP/1.0 200 OK
CSeq: 4
Session: <SessionId>;timeout=120
Transport: RTP/AVP/UDP;unicast;client_port=<CliUdpPortV>-<CliUdpPortV+1>;
server_port=<SrvUdpPortV>-<SrvUdpPortV+1>;ssrc=<SSRC>

```

#### UDP Unicast Packets (1/2)

```
SETUP rtsp://<cam_ip>/mediainput/h264/stream_1/trackID=2 RTSP/1.0
CSeq: 5
User-Agent: <User-Agent>
Transport: RTP/AVP;unicast;client_port=<CliUdpPortA>-<CliUdpPortA+1>
Session: <SessionId>

RTSP/1.0 200 OK
CSeq: 5
Session: <SessionId>;timeout=120
Transport: RTP/AVP/UDP;unicast;client_port=<CliUdpPortA>-<CliUdpPortA+1>;
server_port=<SrvUdpPortA>-<SrvUdpPortA+1>;ssrc=<SSRC>

PLAY rtsp://<cam_ip>/mediainput/h264/stream_1/ RTSP/1.0
CSeq: 6
User-Agent: <User-Agent>
Session: <SessionId>
Range: npt=0.000-

RTSP/1.0 200 OK
CSeq: 6
Session: <SessionId>
RTP-Info: url=trackID=1;seq=<SequenceNumber>;rtptime=...
url=trackID=2;seq=<SequenceNumber>;rtptime=...

<VIDEO Stream in RTP payload over UDP>
<AUDIO Stream in RTP payload over UDP>

GET_PARAMETER rtsp://<cam_ip>/mediainput/h264/stream_1/ RTSP/1.0
CSeq: 7
User-Agent: <User-Agent>
Session: <SessionId>

RTSP/1.0 200 OK
CSeq: 7
Session: <SessionId>

TEARDOWN rtsp://<cam_ip>/mediainput/h264/stream_1/ RTSP/1.0
CSeq: 8
User-Agent: <User-Agent>
Session: <SessionId>

RTSP/1.0 200 OK
CSeq: 8
Session: <SessionId>
```

#### UDP Unicast Packets (2/2)

## 11.2. UDP Multicast

You must make the settings described below in the WEB menu as preparations at the remote camera side.

- Set H264(X)/Transmission type to Multicast.
- Set H264(X)/Multicast address (set to 239.192.0.20 for H264(1) according to factory settings)
- Set H264(X)/Multicast port (set to 37004 for H264(1) according to factory settings)

The port number and multicast address during transmission of the video and audio stream depend on the values of the WEB menu of the remote camera, and the commands from the client side are ignored.

The acquisition method of video and audio stream by the UDP Multicast method is illustrated below.

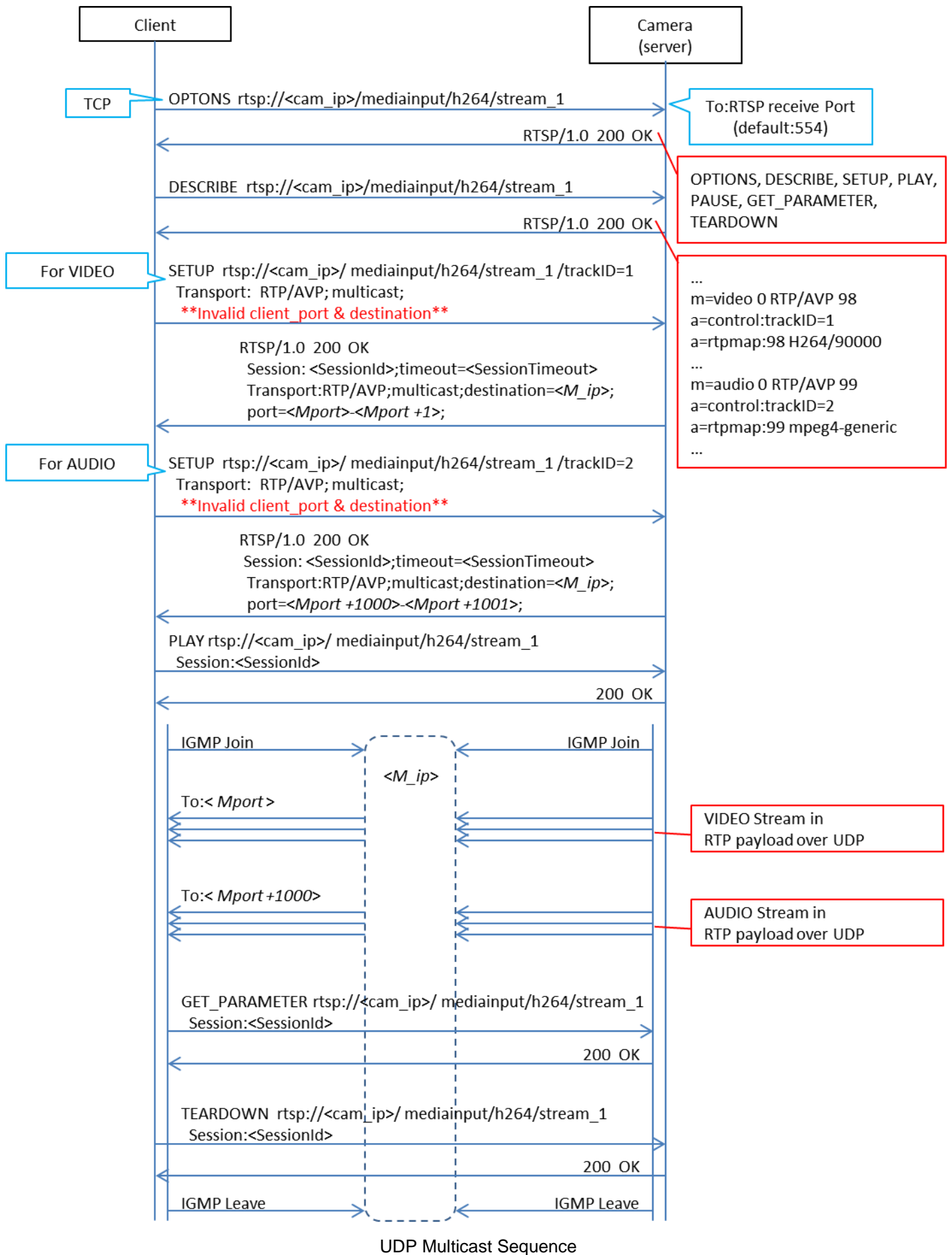

```

OPTIONS rtsp://<cam_ip>/mediainput/h264/stream_1 RTSP/1.0
CSeq: 2
User-Agent: <User-Agent>

RTSP/1.0 200 OK
CSeq: 2
Public: OPTIONS, DESCRIBE, SETUP, PLAY, PAUSE, GET_PARAMETER, TEARDOWN

DESCRIBE rtsp://<cam_ip>/mediainput/h264/stream_1 RTSP/1.0
CSeq: 3
User-Agent: <User-Agent>

RTSP/1.0 200 OK
CSeq: 3
Content-Base: rtsp://<cam_ip>/mediainput/h264/stream_1/
Content-Type: application/sdp
Content-Length: <Length>

v=0
o=- 1 1 IN IP4 <cam_ip>
s=Media Presentation
e=NONE
c=IN IP4 0.0.0.0
b=AS:14464
t=0 0
a=control:*
a=range:npt=now-
m=video 0 RTP/AVP 98
b=AS:14336
a=framerate:30.0
a=control:trackID=1
a=rtpmap:98 H264/90000
a=fmtp:98 packetization-mode=1
a=h264-esid:201
m=audio 0 RTP/AVP 99
a=control:trackID=2
a=rtpmap:99 mpeg4-generic/48000/2
a=fmtp:99 streamType=5; profile-level-id=41; mode=AAC-hbr; config=1190; sizeLength=13; indexLength=3;
indexDeltaLength=3; bitrate=128000
a=h264-esid:101

SETUP rtsp://<cam_ip>/mediainput/h264/stream_1/trackID=1 RTSP/1.0
CSeq: 4
User-Agent: <User-Agent>
Transport: RTP/AVP;multicast;client_port=52944-52945

RTSP/1.0 200 OK
CSeq: 4
Session: <SessionId>;timeout=120
Transport: RTP/AVP/UDP;multicast;destination=<M_ip>;
ttl=16;port=<Mport>-<Mport+1>

```

UDP Multicast Packets (1/2)

```
SETUP rtsp://<cam_ip>/mediainput/h264/stream_1/trackID=2 RTSP/1.0
CSeq: 5
User-Agent: <User-Agent>
Transport: RTP/AVP;multicast;client_port=52946-52947
Session: <SessionId>
```

```
RTSP/1.0 200 OK
CSeq: 5
Session: <SessionId>;timeout=120
Transport: RTP/AVP/UDP;multicast;destination=<M_ip>;
ttl=16;port=<Mport+1000>-<Mport+1001>
```

```
PLAY rtsp://<cam_ip>/mediainput/h264/stream_1/ RTSP/1.0
CSeq: 6
User-Agent: <User-Agent>
Session: <SessionId>
Range: npt=0.000-
```

```
RTSP/1.0 200 OK
CSeq: 6
Session: <SessionId>
RTP-Info: url=trackID=1;seq=<SequenceNumber>;rtptime=...
          url=trackID=2;seq=<SequenceNumber>;rtptime=...
```

```
GET_PARAMETER rtsp://<cam_ip>/mediainput/h264/stream_1/ RTSP/1.0
CSeq: 7
User-Agent: <User-Agent>
Session: <SessionId>
```

```
RTSP/1.0 200 OK
CSeq: 7
Session: <SessionId>
```

UDP Multicast Packets (2/2)



## 11.3. TCP Unicast

You must make the settings described below in the WEB menu as preparations at the remote camera side.

- Set H264(X)/Transmission type to Unicast (AUTO).

The port number during transmission of video and audio stream is decided as described below.

- client\_port (receiving port at the client side):

The transmission-side port of the client that is used in the RTSP "PLAY" sequence becomes the receiving port at the client side.

\* The methods of deciding the port number differ according to the client, and include random settings and dedicated menu.

- server\_port (transmitting port of the remote camera):

The RTSP waiting port (set to 554 according to factory settings) is used.

The interleave header specified from the client side is ignored at the camera side, and a new interleave header is issued.

The acquisition method of video and audio stream by the TCP Unicast method is illustrated below.

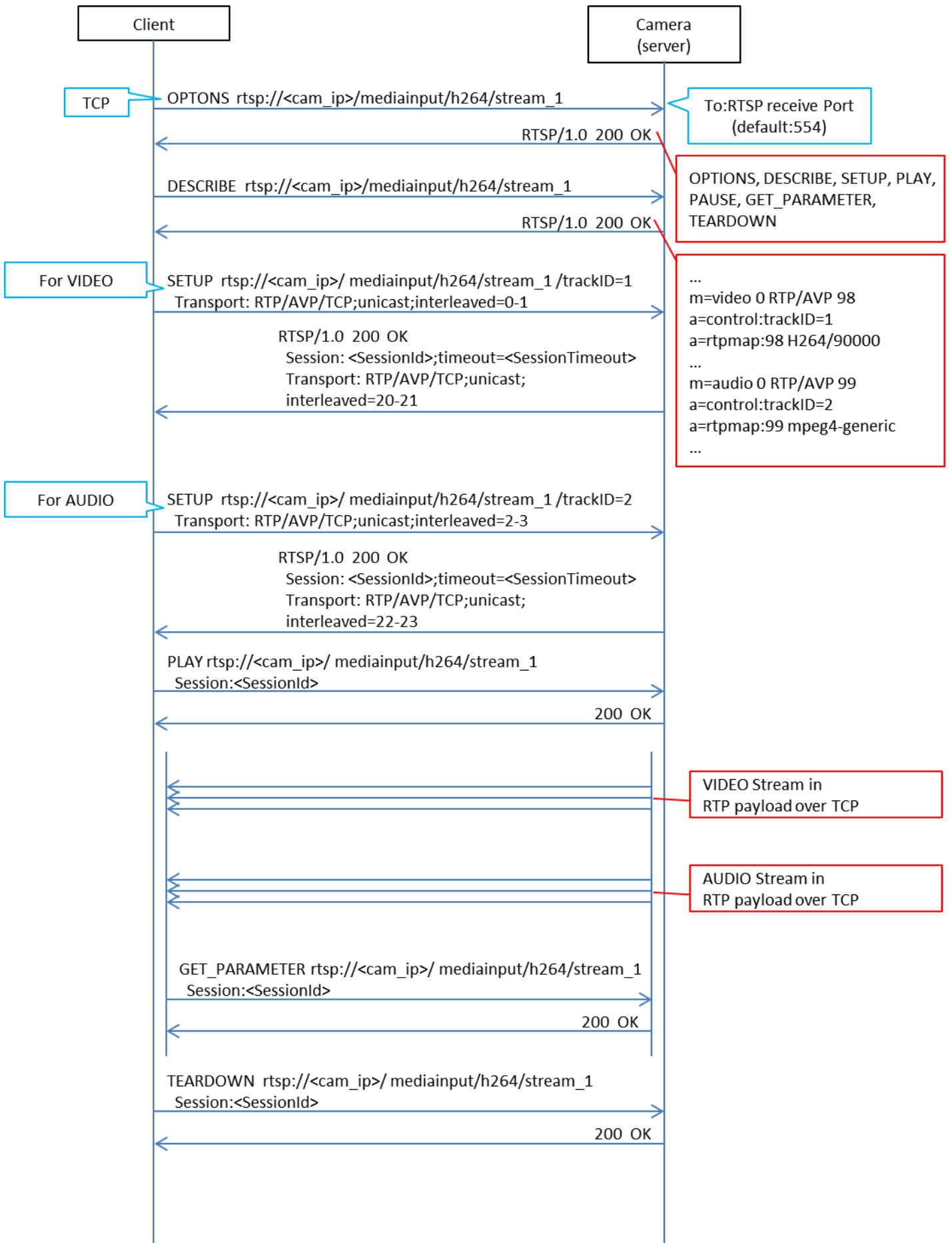

TCP Unicast Sequence

OPTIONS rtsp://<cam\_ip>/mediainput/h264/stream\_1 RTSP/1.0

CSeq: 2

User-Agent: <User-Agent>

RTSP/1.0 200 OK

CSeq: 2

Public: OPTIONS, DESCRIBE, SETUP, PLAY, PAUSE, GET\_PARAMETER, TEARDOWN

DESCRIBE rtsp://<cam\_ip>/mediainput/h264/stream\_1 RTSP/1.0

CSeq: 3

User-Agent: <User-Agent>

Accept: application/sdp

RTSP/1.0 200 OK

CSeq: 3

Content-Base: rtsp://<cam\_ip>/mediainput/h264/stream\_1/

Content-Type: application/sdp

Content-Length: <Length>

v=0

o=- 1 1 IN IP4 <cam\_ip>

s=Media Presentation

e=NONE

c=IN IP4 0.0.0.0

b=AS:14464

t=0 0

a=control:\*

a=range:npt=now-

m=video 0 RTP/AVP 98

b=AS:14336

a=framerate:30.0

a=control:trackID=1

a=rtpmap:98 H264/90000

a=fmtp:98 packetization-mode=1

a=h264-esid:201

m=audio 0 RTP/AVP 99

a=control:trackID=2

a=rtpmap:99 mpeg4-generic/48000/2

a=fmtp:99 streamType=5; profile-level-id=41; mode=AAC-hbr; config=1190; sizeLength=13;

indexLength=3; indexDeltaLength=3; bitrate=128000

a=h264-esid:101

SETUP rtsp://<cam\_ip>/mediainput/h264/stream\_1/trackID=1 RTSP/1.0

CSeq: 4

User-Agent: <User-Agent>

Transport: RTP/AVP/TCP;unicast;interleaved=0-1

RTSP/1.0 200 OK

CSeq: 4

Session: <SessionId>;timeout=120

Transport: RTP/AVP/TCP;unicast;interleaved=20-21;ssrc=<SSRC>

TCP Unicast Packets 1/2

SETUP rtsp://<cam\_ip>/mediainput/h264/stream\_1/trackID=2 RTSP/1.0

CSeq: 5

User-Agent: <User-Agent>

Transport: RTP/AVP/TCP;unicast;interleaved=2-3

Session: <SessionId>

RTSP/1.0 200 OK

CSeq: 5

Session: <SessionId>;timeout=120

Transport: RTP/AVP/TCP;unicast;interleaved=22-23;ssrc=<SSRC>

PLAY rtsp://<cam\_ip>/mediainput/h264/stream\_1/ RTSP/1.0

CSeq: 6

User-Agent: <User-Agent>

Session: <SessionId>

Range: npt=0.000-

RTSP/1.0 200 OK

CSeq: 6

Session: <SessionId>

RTP-Info: url=trackID=1;seq=<SequenceNumber>;rtptime=...

url=trackID=2;seq=<SequenceNumber>;rtptime=...

GET\_PARAMETER rtsp://<cam\_ip>/mediainput/h264/stream\_1/RTSP/1.0

CSeq: 7

User-Agent: <User-Agent>

Session: <SessionId>

RTSP/1.0 200 OK

CSeq: 7

Session: <SessionId>

TCP Unicast Packets 2/2

## 11.4 About the rtpmap Attribute

The response of "rtpmap" with respect to the RTSP "DESCRIBE" request is as described below.

Codec	rtpmap Attribute Value
<b>H.264</b>	a=rtpmap:98 H264/90000
<b>AAC</b>	a=rtpmap:99 mpeg4-generic/48000/2

The values described above are used for both video and audio regardless of the bit rate.

## 12. About Control Based on RTCP

The remote camera also supports dynamic control of bit rate and frame rate according to the line status using RTCP. As a prerequisite, a client that supports RTCP/SR (Sender Report) and RTCP/RR (Receiver Report) is necessary.

You must make the settings described below in the WEB menu as preparations at the remote camera side.

- Set H264(X)/Transmission priority to Best effort.
  - \* In the case of the frame rate (factory settings) and constant bit rate, an RTCP/SR is transmitted and an RTCP/RR is received, but these are not used for controlling the bit rate and frame rate.
- Select H264(X)/Image quality from Motion priority or Image quality priority.
  - Motion priority: This is the motion priority mode. The bit rate is actively changed and supported.
  - Image quality priority: This is the image quality priority mode. The frame rate is actively changed.

The sequence during RTCP control is illustrated below:

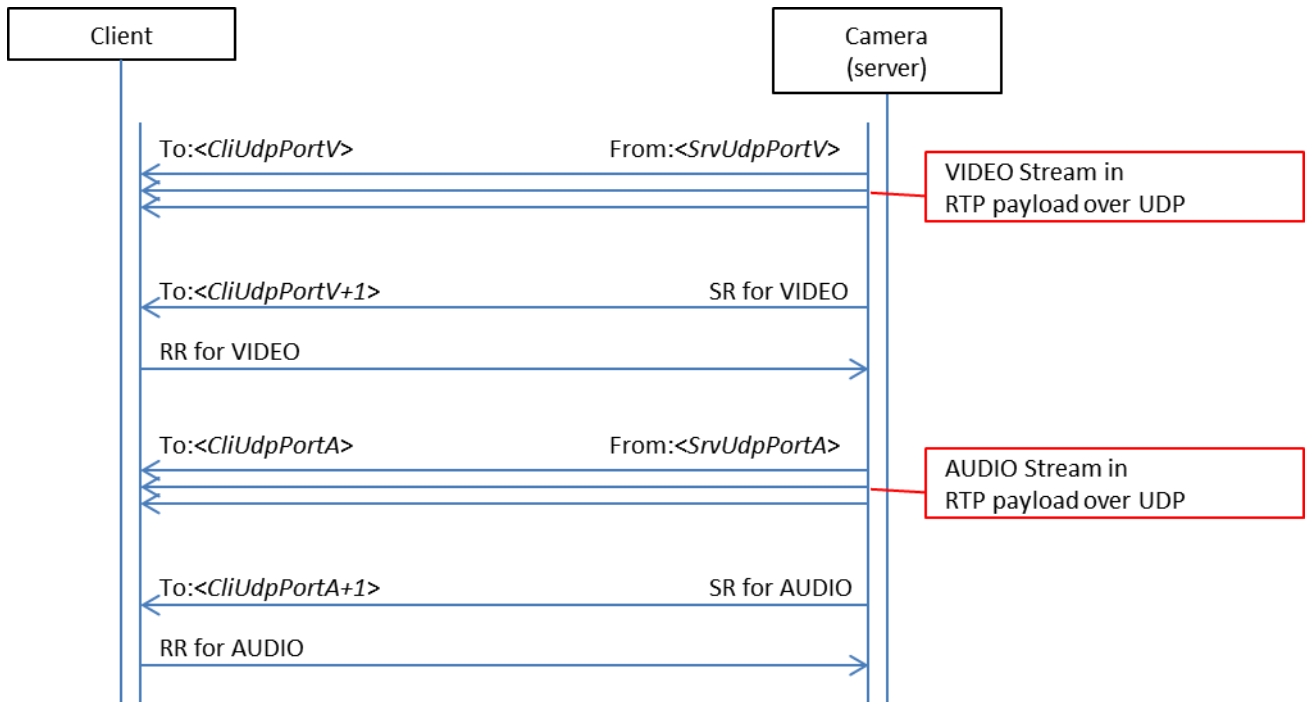

Note that in the remote camera, an RTCP/SR is transmitted every five seconds, and of the RTCP/RRs, only those related to VIDEO are used.

## 13. About RTP/Data Format

### 13.1. RTP Header Format

Byte	0.				8.		16.	24.
	2	1	1	4	1	7	8	8
0	V	P	X	CC	M	PT	Sequence number	
4	Timestamp							
8	SSRC (Synchronization Source Identifier)							
12	Defined by profile				Extension length			
16	Additional Information (1)							
	Additional Information (N)							

Parameter name	length(Bit)	Values and comments
V (Version)	2	2 (fixed)
P (Padding)	1	0 (fixed)
X (Extension)	1	0: false , 1: true
CC (CSRC Count)	4	0 (fixed)
M (Marker)	1	In case of the last RTP packet of a picture, this value is set to 1
PT (Payload Type)	7	98 (fixed for H.264) 99 (fixed for AAC)
Sequence number	16	The value in which one increment is done in each RTP packet is set. An initial value is generated at random.
Timestamp	32	Time stamp
SSRC	32	0x0000 0000 (fixed)
CSRC	0	Unused
Defined by profile(*)	16	0 (fixed)
Extension length(*)	16	Length of the Header Extension (Unit of 32bit word)
meta information (Additional Information) (*)		

## 13.2. Relationship with H.264/ES Data

The structure of ES data and RTP packet of H.264 is as shown below.

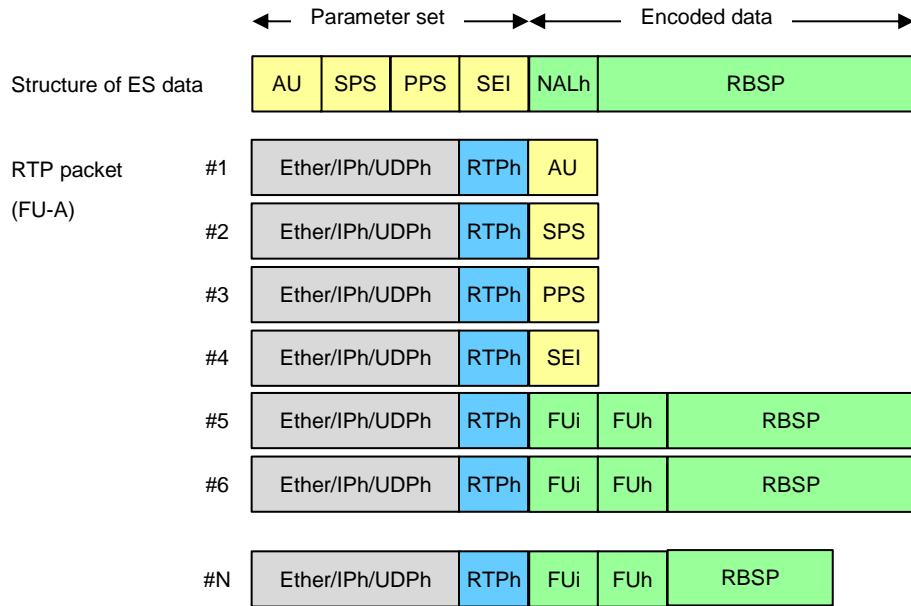

[Notes]

NALh	:	NAL header (1 byte)
Fui	:	FU identifier (1 byte)
Fuh	:	FU header (1 byte)
Ether/IPh/UDPh	:	Ether/IP header/UDP header
RTP	:	RTP header



### 13.3. H.264 Syntax

In the remote camera, the Codec information to be used changes depending on the resolution/frame rate. The following information is used when Priority Mode is IP or IP (4K) and 59.94 Hz is set, it is as follows.

Resolution / Frame rate	Codec Info
320x180/5p,15p,30p 640x360/5p,15p,30p 1280x720/5p,15p,30p,60p 1920x1080/5p,15p,30p	H.264/High profile (no B frame/CAVLC) GOP interval approx 1 sec.
1920x1080/60p	H.264/High profile (no B frame/CABAC) GOP interval approx 1 sec.
3840x2160/5p,15p(*1)	H.264/High profile (no B frame/CABAC) GOP interval approx 0.5 sec.
3840x2160/30p(*1)	H.264/High profile (B frame present/CABAC) GOP interval approx 0.5 sec.

(\*1): Only for UE70 series

### 13.4. Audio Data Format

The structure of the audio ES data and RTP packet differs depending on the audio compression method.

When the audio compression method is AAC:

An AU header (2 bytes) is inserted between the RTP header and audio data, and then transmitted.

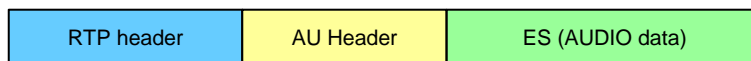

Memo: