

# Edixeon<sup>®</sup> S series



Edixeon<sup>®</sup> S series emitters are one of the highest flux LEDs in the world by Edison Opto. Edixeon<sup>®</sup> S series emitters are designed to satisfy more and more Solid-State lighting High Power LED applications for brilliant world such as flash light, indoor and outdoor decoration light. Edixeon<sup>®</sup> S series emitters are designed by particular package for reflow process application. Unlike most fluorescent sources, Edixeon<sup>®</sup> S series contains no mercury and has more energy efficient than other incandescent light source.

## Features

- Low voltage operation
- Instant on
- Long life

## Typical Applications

- Stage Lighting
- Up-lights and Down-lights
- LCD Backlights
- Contour lights
- Ceiling lights
- Garden lighting
- Decoration lights
- Architectural lighting
- Beacon light

---

## Table of Contents

Product Nomenclature .....	2
Environmental Compliance .....	3
LED Package Dimensions and Polarity .....	4
LED Package with Star Dimensions and Polarity .....	5
Absolute Maximum Ratings .....	6
Luminous Flux Characteristics .....	8
Forward Voltage Characteristics .....	9
Reliability Items and Failure Measures .....	10
Color Spectrum and Radiation Pattern.....	11
JEDEC Information .....	16
Optical & Electrical Characteristics .....	17
Product Soldering Instructions .....	23
Product Thermal Application Information .....	27
Product Electrical Application Information.....	32
Emitter Product Packaging Information.....	33
Star Product Packaging Information.....	35

## Product Nomenclature

The following table describes the available color, power, and lens type. For more flux and forward voltage information, please consult the Bin Group document.

< Table 1 Edixeon® S series nomenclature >

E D E R - S L C 3 - 0 3 - A B 16

X1 X2 X3 X4 X5 X6 X7 X8 X9 X10 X11 X12

X1 LED Item		X2 Module		X3 Emitting Color		X4 Power		X5 Lens Item		X6 Housing Item		
Code	Type	Code	Type	Code	Type	Code	Type	Code	Type	Code	Type	
ED	Edixeon®	E	Emitter	W	Cool White	○	1	1W	L	Lambertian	C	Black-2
		S	Star	H	Neutral White	●	3	3W				
				X	Warm White	●	5	5W				
				R	Red	●						
				A	Amber	●						
				T	True Green	●						
				B	Blue	●						
				D	Dental Blue	●						
				C	Royal Blue	●						
				J	Cyan	●						
				V	Ultraviolet	●						

X7 Material		X8 Phosphor Item		X9 Testing Current		X10 Shape Item		X11 Al PCB Color		X12 Thickness	
				Code	Type	Code	Type	Code	Type	Code	Type
				1	350mA	A	Star	W	White	10	1.0mm
				3	700mA	B	Square(25*25mm)	G	Green	16	1.6mm
						C	Square(30*30mm)	B	Black	20	2.0mm

### Environmental Compliance

Edixeon<sup>®</sup> S series are compliant to the Restriction of Hazardous Substances Directive or RoHS. The restricted materials including lead, mercury cadmium hexavalent chromium, polybrominated biphenyls (PBB) and polybrominated diphenyl ether (PBDE) are not used in Edixeon<sup>®</sup> S series to provide an environmentally friendly product to the customers.

## LED Package Dimensions and Polarity

### Lambertian

Top View

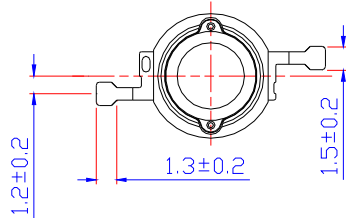

Bottom View

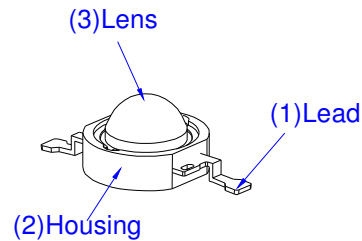
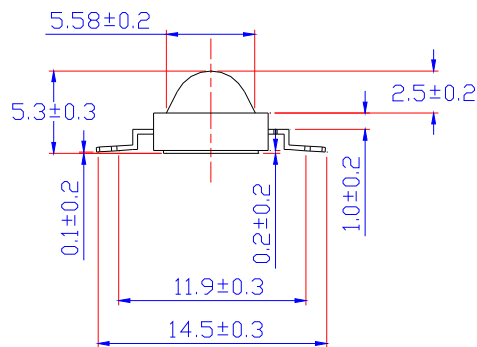
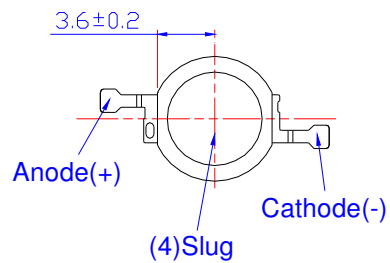

Side View

Circuit

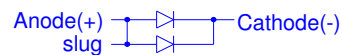
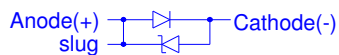

EDER-1LS3      EDER-SLS3-03  
 EDEA-1LS3      EDET-SLC5-03  
 EDET-1LS1      EDEB-SLC5-03  
 EDEJ-1LS1      EDEC-SLC5-03  
 EDEB-1LS5      EDED-SLC5-03  
 EDEC-1LS5  
 EDED-1LS5  
 EDEV-1LS1

EDEA-SLC3-03  
 EDEV-SLC1-03  
 EDEJ-SLC1-03

< Figure 1 Edixeon<sup>®</sup> S series dimensions >

#### Notes:

1. All dimensions are measured in mm.

## LED Package with Star Dimensions and Polarity

### EDSx-xxxx-xx-Ax16

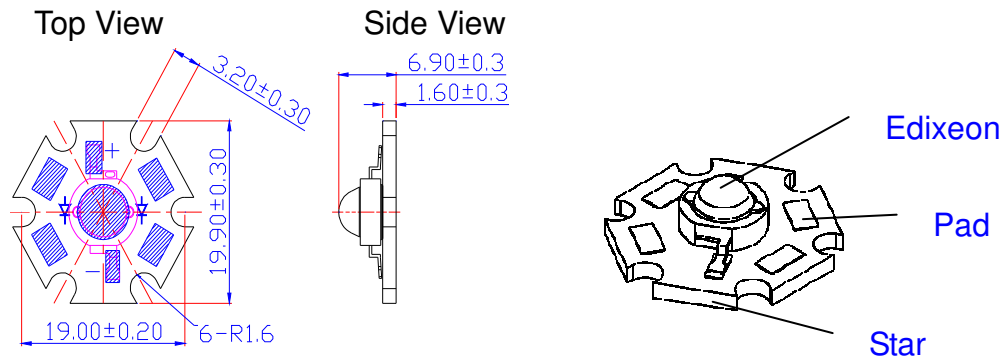

### EDSx-xxxx-xx-Bx16

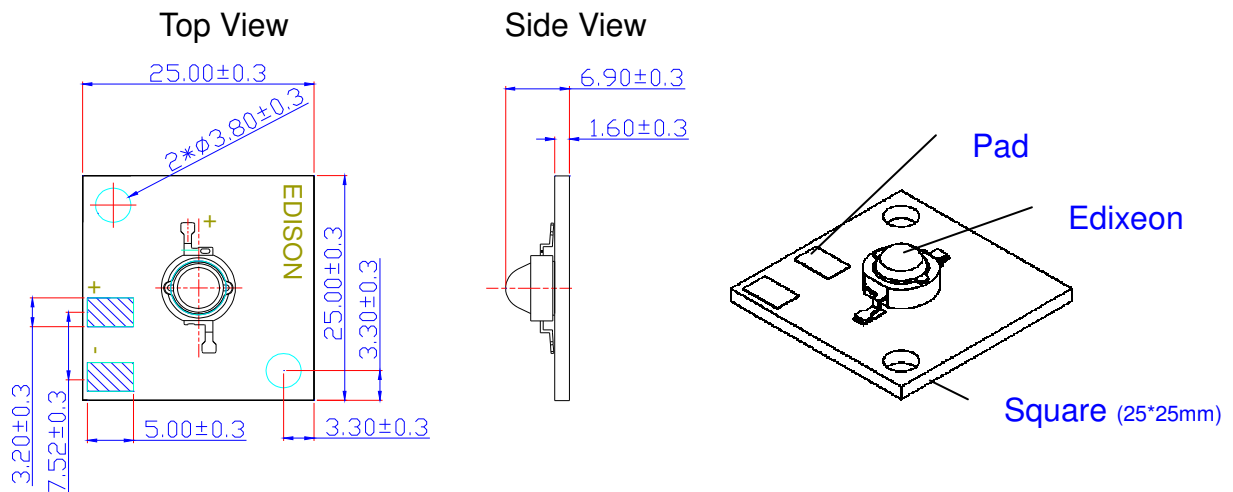

### EDSx-xxxx-xx-Cx16

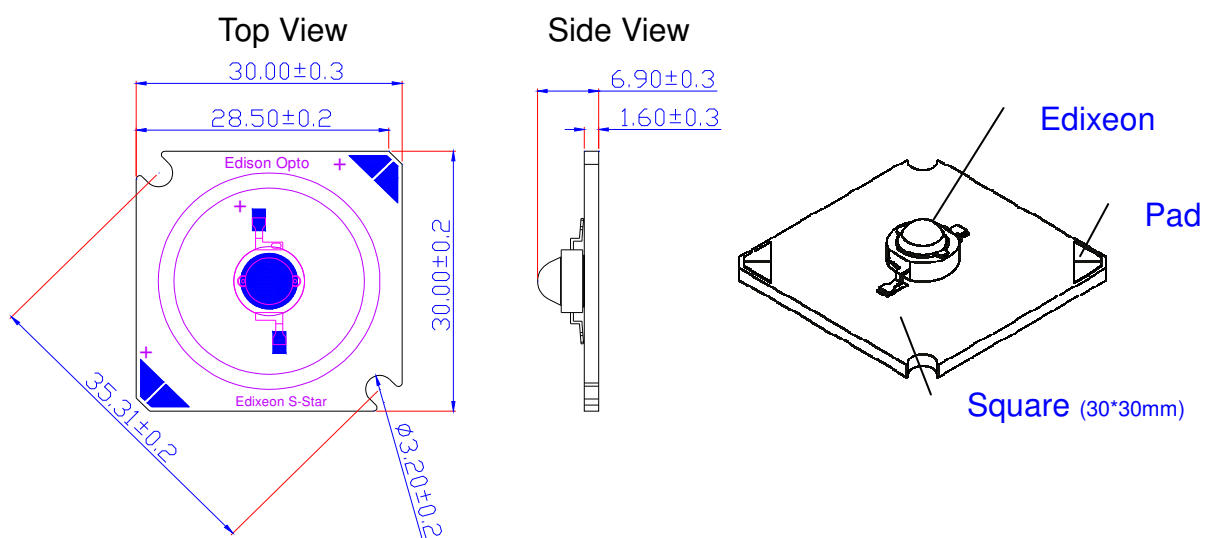

<Figure 2 Edixeon® star dimensions>

#### Notes:

- 1.All Dimensions are in mm.

## Absolute Maximum Ratings

The following tables describe the characteristics of Edixeon® S series under various current.

< Table 2 Edixeon® S series absolute maximum ratings >

Parameter	Rating(1W)	Rating(3W)	Unit	Symbol
DC Forward Current	350	700	mA	I <sub>F</sub>
Peak pulse current (tp ≤ 100μs, Duty cycle=0.25)	700	1,000	mA	
Reverse Voltage	5	5	V	V <sub>R</sub>
Drive Voltage	5	5	V	V <sub>D</sub>
LED junction Temperature	125	125	°C	T <sub>J</sub>
Operating Temperature	-30 ~ +110	-30 ~ +110	°C	
Storage Temperature	-40 ~ +120	-40 ~ +120	°C	
Storage Relative Humidity	60	60	%	
ESD Sensitivity	4,000	4,000	V	V <sub>B</sub>
Manual Soldering Time at 260°C (Max.)	5	5	Sec.	

### Notes:

1. Proper current derating must be observed to maintain junction temperature below the maximum at all time.
2. LEDs are not designed to be driven in reverse bias.
3. tp: Pulse width time

The following table describes thermal resistance of Edixeon<sup>®</sup> S series.

< Table 3 Thermal Resistance Junction to Solder Pad Characteristics at  $T_J=25^{\circ}\text{C}$  for Edixeon<sup>®</sup>

S series>

Part Name	Typ.	$R_{\theta_{J-B}}$	Unit
EDER-1LS3	14		$^{\circ}\text{C/W}$
EDEA-1LS3	13		$^{\circ}\text{C/W}$
EDET-1LS1	13		$^{\circ}\text{C/W}$
EDEJ-1LS1	13		$^{\circ}\text{C/W}$
EDEB-1LS5	13		$^{\circ}\text{C/W}$
EDEC-1LS5	13		$^{\circ}\text{C/W}$
EDED-1LS5	13		$^{\circ}\text{C/W}$
EDEV-1LS1	13		$^{\circ}\text{C/W}$
EDER-SLC3-03	14		$^{\circ}\text{C/W}$
EDEA-SLC3-03	14		$^{\circ}\text{C/W}$
EDET-SLC5-03	13		$^{\circ}\text{C/W}$
EDEJ-SLC1-03	13		$^{\circ}\text{C/W}$
EDEB-SLC5-03	13		$^{\circ}\text{C/W}$
EDEC-SLC5-03	13		$^{\circ}\text{C/W}$
EDED-SLC5-03	13		$^{\circ}\text{C/W}$
EDEV-SLC1-03	13		$^{\circ}\text{C/W}$



## Luminous Flux Characteristics

The following tables describe flux of Edixeon<sup>®</sup> S series under various current and different color.

< Table 4 Power and Luminous flux characteristics at  $I_f=350\text{mA}$  and  $T_J=25^\circ\text{C}$  : >

Lens Item	Part Name	Color	Flux / Pwoer			Unit
			Min.	Typ.	Max.	
Lambertian	EDER-1LS3	Red	30.3	45.0	--	lm
	EDEA-1LS3	Amber	30.3	45.0	--	lm
	EDET-1LS1	True Green	51.2	70.0	--	lm
	EDEJ-1LS1	Cyan	23.3	30.0	--	lm
	EDEB-1LS5	Blue	8.2	20.0	--	lm
	EDEC-1LS5*	Royal Blue	170.9	320.0	--	mW
	EDED-1LS5*	Dental Blue	170.9	320.0	--	mW
	EDEV-1LS1*	UV	113.9	180.0	--	mW

< Table 5 Power and Luminous flux characteristics at  $I_f=700\text{mA}$  and  $T_J=25^\circ\text{C}$  : >

Lens Item	Part Name	Color	Flux / Pwoer			Unit
			Min.	Typ.	Max.	
Lambertian	EDER-SLC3-03	Red	66.5	80.0	--	lm
	EDEA-SLC3-03	Amber	66.5	80.0	--	lm
	EDET-SLC5-03	True Green	86.5	120.0	--	lm
	EDEJ-SLC1-03	Cyan	39.3	50.0	--	lm
	EDEB-SLC5-03	Blue	13.8	30.0	--	lm
	EDEC-SLC5-03*	Royal Blue	256.3	600.0	--	mW
	EDED-SLC5-03*	Dental Blue	256.3	600.0	--	mW
	EDEV-SLC1-03*	UV	170.9	400.0	--	mW

### Notes:

1. Flux is measured with an accuracy of  $\pm 10\%$
2. Blue power light source represented here is IEC60825 class 2 for eye safety.
3. Red and true green light source represented here are IEC60825 class 1 for eye safety.
4. \* Mark is power characteristics

## Forward Voltage Characteristics

The following table describes forward voltage of Edixon® S series under various current.

< Table 6 Forward voltage characteristics at  $I_F=350\text{mA}$  &  $700\text{mA}$  and  $T_J=25^\circ\text{C}$  >

Lens Item	Part Name	Forward Current (mA)	$V_F$			Unit
			Min.	Typ.	Max.	
Lambertian	EDER-1LS3	350	2.0	--	3.0	V
	EDEA-1LS3		2.0	--	3.0	
	EDET-1LS1		3.1	--	4.0	
	EDEJ-1LS1		3.1	--	4.0	
	EDEB-1LS5		3.1	--	4.0	
	EDEC-1LS5		3.1	--	4.0	
	EDED-1LS5		3.1	--	4.0	
	EDEV-1LS1		3.1	--	4.0	
	EDER-SLC3-03		700	2.0	--	
	EDEA-SLC3-03	2.0		--	3.0	
	EDET-SLC5-03	3.4		--	4.3	
	EDEJ-SLC1-03	3.4		--	4.3	
	EDEB-SLC5-03	3.4		--	4.3	
	EDEC-SLC5-03	3.4		--	4.3	
	EDED-SLC5-03	3.4		--	4.3	
	EDEV-SLC1-03	3.4		--	4.3	

### Note:

1. Forward voltage is measured with an accuracy of  $\pm 0.1\text{V}$

## Reliability Items and Failure Measures

### Reliability test

The following table describes operating life, mechanical, and environmental tests performed on Edixeon® S series package.

< Table 7 Operating life, mechanical, and environmental characteristics at  $I_F=350\text{mA}\sim 700\text{mA}$  and  $T_J=25^\circ\text{C}$  >

Stress Test	Stress Conditions	Stress Duration	Failure Criteria
Room Temperature Operating Life	$25^\circ\text{C}$ , $I_F = \text{max DC}$ (Note 1)	1,000 hours	Note 2
High Temperature High Humidity	$85^\circ\text{C}$ / 85%RH	1,000 hours	Note 2
Temperature Cycle	$-40^\circ\text{C}/100^\circ\text{C}$ ,30 min dwell / <5min transfer	500 cycles	Note 2
High Temperature Storage Life	$110^\circ\text{C}$	1,000 hours	Note 2
Low Temperature Storage Life	$-40^\circ\text{C}$	1,000 hours	Note 2
Thermal Shock	$-40 / 125^\circ\text{C}$ , 15 min dwell / <10 sec transfer	1,000 cycles	No catastrophics
Mechanical Shock	1500 G, 0.5 Ms pulse, 5 shocks each of 6 axis		No catastrophics
Solder Heat Resistance (SHR)	$260^\circ\text{C} \pm 5^\circ\text{C}$ , 10 sec		No catastrophics

#### Notes:

1. Depending on the maximum derating curve.
2. Failure Criteria:
  - Electrical failures
  - $V_F$  shift  $\geq 10\%$
  - Light Output Degradation
  - %  $I_v$  shift  $\geq 30\%$  @1,000hrs or 200cycle
  - Visual failures
  - Broken or damaged package or lead
  - Solderability < 95% wetting
  - Dimension out of tolerance

## Color Spectrum and Radiation Pattern

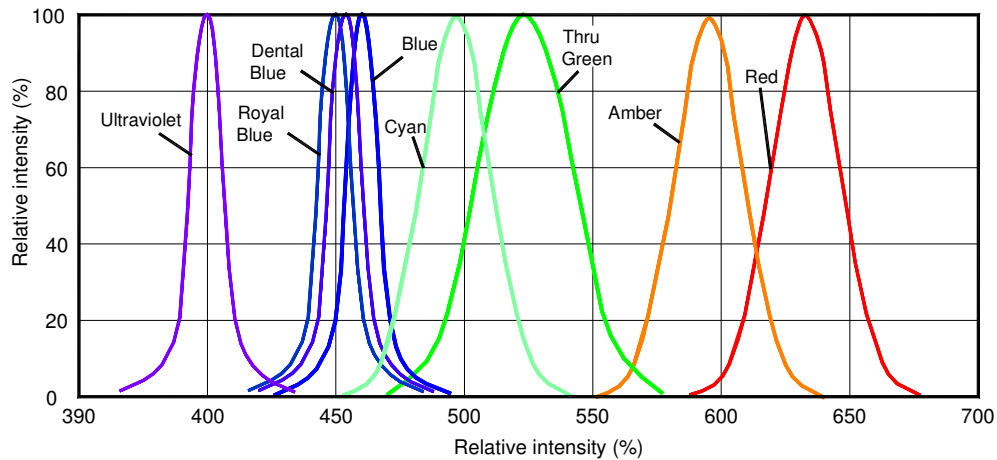

<Figure 3. Color spectrum at  $T_J = 25^\circ\text{C}$ . for Edixeon® S series >

## Color Temperature or Dominant Wavelength Characteristics

< Table 8 Dominant Wavelength and Peak Wavelength Characteristics at  $T_J = 25^\circ\text{C}$  >

Lens Item	Part Name	Color	$\lambda_d/\lambda_P^*$			Unit
			Min.	Typ.	Max.	
Lambertian	EDER-1LS3	Red	620	--	630	nm
	EDEA-1LS3	Amber	585	--	595	nm
	EDET-1LS1	True Green	515	--	530	nm
	EDEJ-1LS1	Cyan	490	--	510	nm
	EDEB-1LS5	Blue	455	--	475	nm
	EDEC-1LS5*	Royal Blue	440	--	460	nm
	EDED-1LS5*	Dental Blue	450	--	470	nm
	EDEV-1LS1*	UV	395	--	410	nm
	EDER-SLC3-03	Red	620	--	630	nm
	EDEA-SLC3-03	Amber	585	--	595	nm
	EDET-SLC5-03	True Green	515	--	535	nm
	EDEJ-SLC1-03	Cyan	490	--	510	nm
	EDEB-SLC5-03	Blue	455	--	475	nm
	EDEC-SLC5-03*	Royal Blue	440	--	460	nm
	EDED-SLC5-03*	Dental Blue	450	--	470	nm
	EDEV-SLC1-03*	UV	395	--	410	nm

**Note:**

- Wavelength is measured with an accuracy of  $\pm 2\text{nm}$

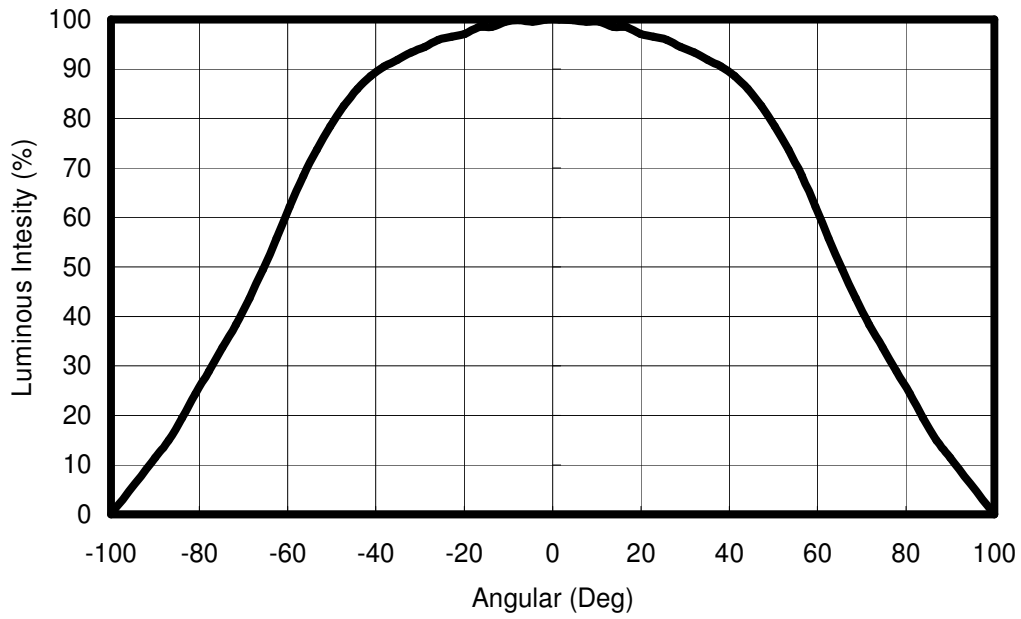

< Figure 4.Lambertain Relative Intensity vs. Angular for EDER · EDEA at  $T_j=25^{\circ}\text{C}$  .>

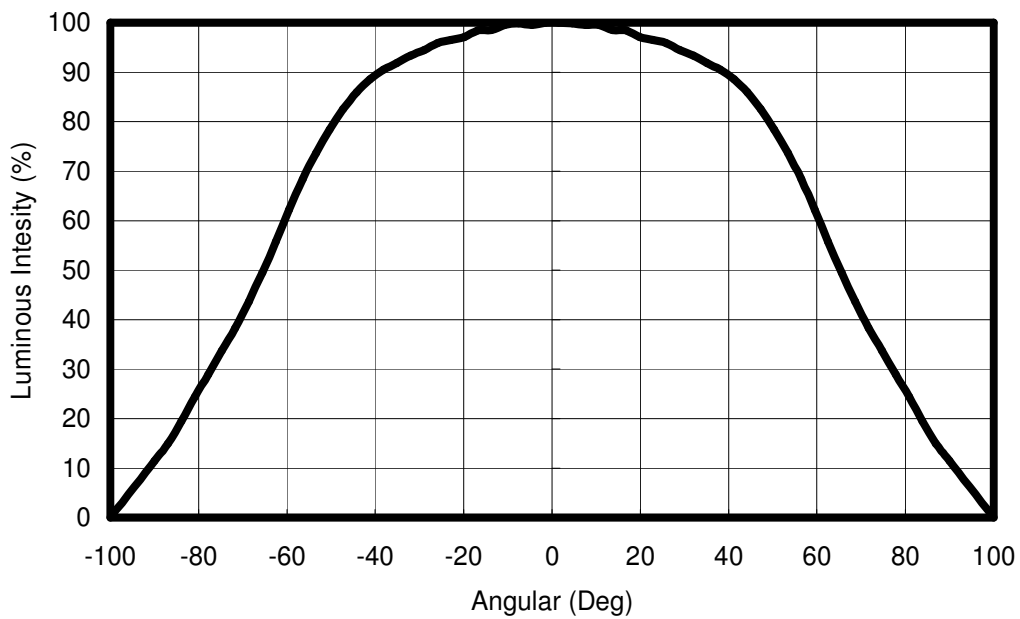

< Figure 5.Lambertain Relative Intensity vs. Angular for EDEA-SLC3-03 X direction at  $T_j=25^{\circ}\text{C}$  .>

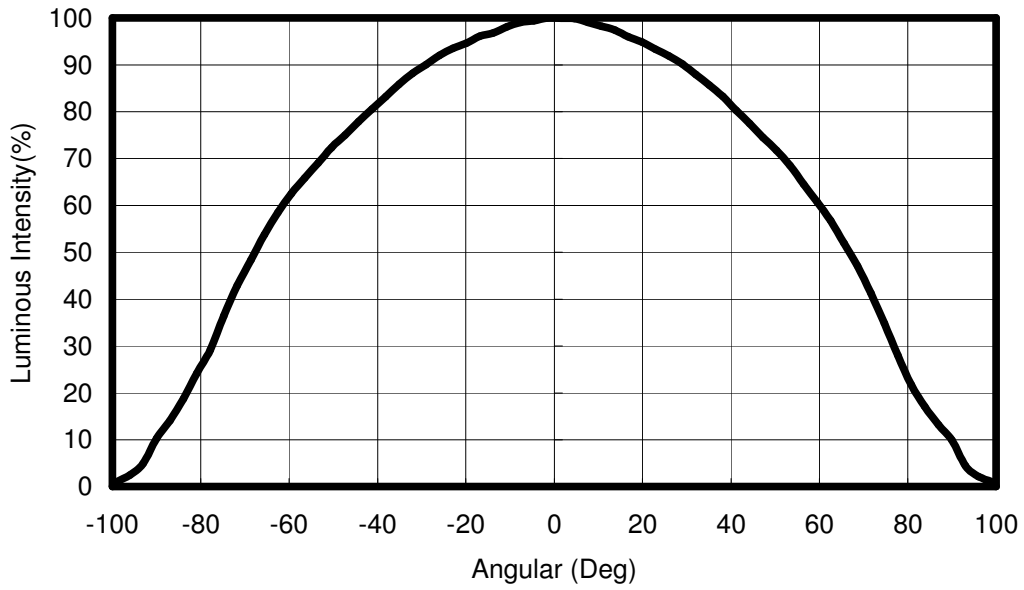

< Figure 6.Lambertain Relative Intensity vs. Angular for EDEA-SLC3-03 Y direction at  $T_J=25^{\circ}\text{C}$ .>

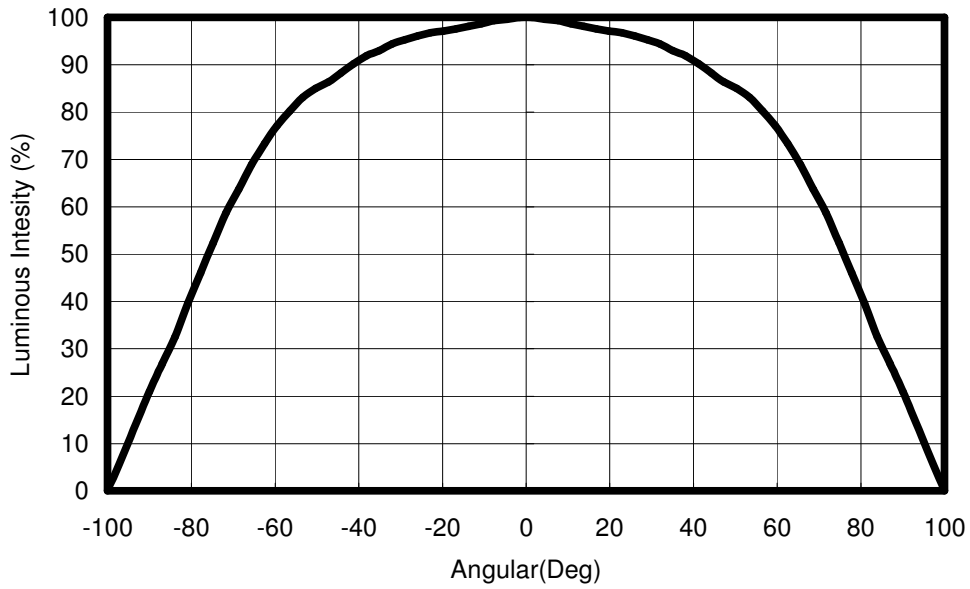

< Figure 7.Lambertain Relative Intensity vs. Angular for EDET-1LS1, EDEB, EDEC, EDED at  $T_J=25^{\circ}\text{C}$ .>

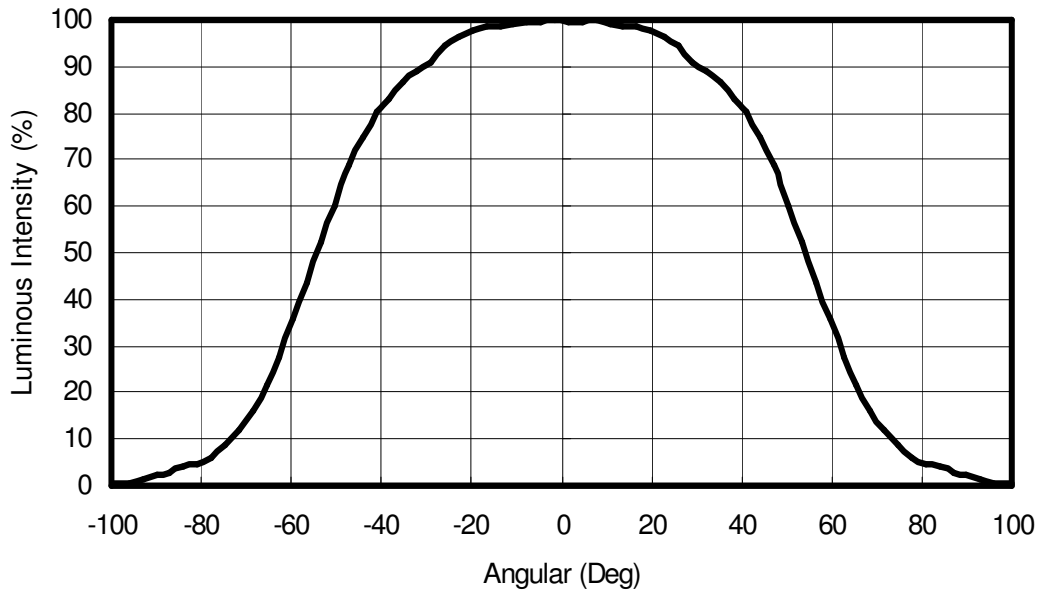

< Figure 8.Lambertain Relative Intensity vs. Angular for EDEJ-SLC1-03、EDEV-SLC1-03, X direction at  $T_J=25^{\circ}\text{C}$ .>

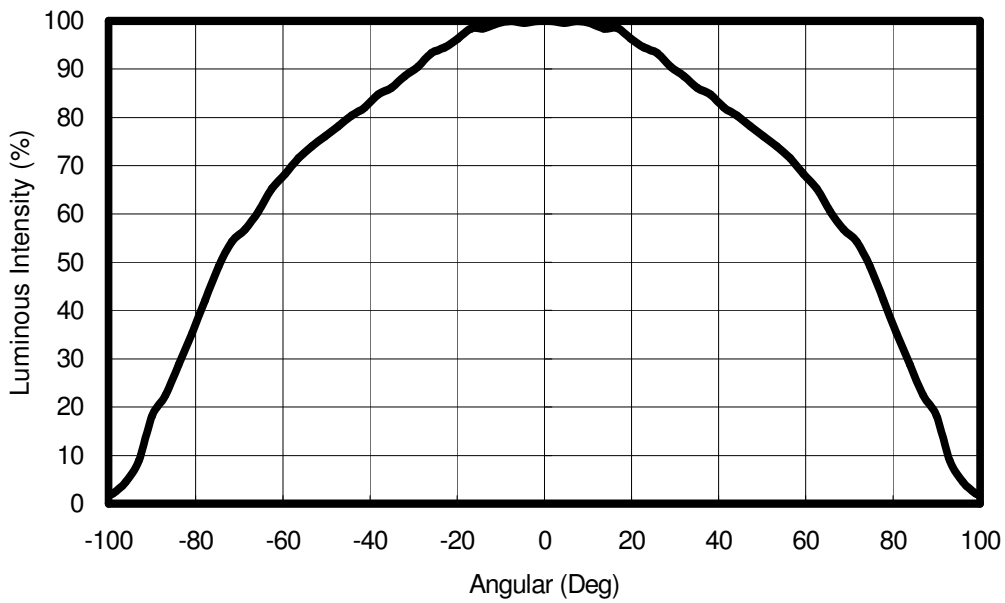

< Figure 9.Lambertain Relative Intensity vs. Angular for EDEJ-SLC1-03、EDEV-SLC1-03, Y direction at  $T_J=25^{\circ}\text{C}$ .>

**Note:**

1. EDEA-SLC3-03、EDEJ-SLC1-03、EDEV-SLC1-03 Testing direction

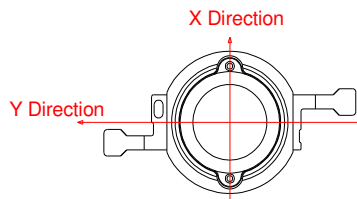

**Emission Angle Characteristics**

< Table 9 Emission angle characteristics at T<sub>J</sub>=25°C >

Lens Item	Part Name	2 $\theta$ <sup>1/2</sup> (Typ.) Lambertian	Unit
	EDER-1LS3	130	Deg.
	EDEA-1LS3	130	Deg.
	EDET-1LS1	150	Deg.
	EDEJ-1LS1	130	Deg.
	EDEB-1LS5	150	Deg.
	EDEC-1LS5	150	Deg.
	EDED-1LS5	150	Deg.
	EDEV-1LS1	150	Deg.
Lambertian	EDER-SLC3-03	130	Deg.
	EDEA-SLC3-03	X : 125 Y : 135	Deg
	EDET-SLC5-03	130	Deg.
	EDEJ-SLC1-03	X : 130 Y : 150	Deg
	EDEB-SLC5-03	130	Deg.
	EDEC-SLC5-03	130	Deg.
	EDED-SLC5-03	150	Deg.
	EDEV-SLC1-03	X : 130 Y : 150	Deg.

**Note:**

1. Emission angular is measured with an accuracy of ± 10 degree



## JEDEC Information

JEDEC has defined a moisture sensitivity classification. So that the users can properly store and handle the devices and to avoid subsequent thermal and mechanical damage during the assembly reflow attachment or repair operation.

The present moisture sensitivity standard contains six levels, the lower the level, the longer the devices floor life. Edixeon<sup>®</sup> K series are certified at level 2a. This means Edixeon<sup>®</sup> K series have a floor life of 4 weeks before K series need to re-baked.

< Table 10 JEDEC characteristics at  $I_F=350mA/700mA/1000mA$  and  $T_J=25^{\circ}C$  >

Level	Floor Life		Soak Requirements				
			Standard		Accelerated Equivalent		
	Time	Condition			Time(hours)	Condition	eV 0.40~0.48 Time(hours)
4	72 hours	$\leq 30^{\circ}C/60\% RH$	96 <sup>1</sup> +5/-0	30 <sup>o</sup> C/60% RH	20 +5/-0	24 +5/-0	60 <sup>o</sup> C/60% RH

Level	Floor Life		Soak Requirements				
			Standard		Accelerated Equivalent		
	Time	Condition			Time(hours)	Condition	eV 0.40~0.48 Time(hours)
1	Unlimited	$\leq 30^{\circ}C/85\% RH$	168 +5/-0	85 <sup>o</sup> C/85% RH	NA	NA	NA
2	1 year	$\leq 30^{\circ}C/60\% RH$	168 +5/-0	85 <sup>o</sup> C/60% RH	NA	NA	NA
2a	4 weeks	$\leq 30^{\circ}C/60\% RH$	696 <sup>1</sup> +5/-0	30 <sup>o</sup> C/60% RH	120 +1/-0	168 +1/-0	60 <sup>o</sup> C/60% RH
3	168 hours	$\leq 30^{\circ}C/60\% RH$	192 <sup>1</sup> +5/-0	30 <sup>o</sup> C/60% RH	40 +5/-0	52 +5/-0	60 <sup>o</sup> C/60% RH
4	72 hours	$\leq 30^{\circ}C/60\% RH$	96 <sup>1</sup> +5/-0	30 <sup>o</sup> C/60% RH	20 +5/-0	24 +5/-0	60 <sup>o</sup> C/60% RH
5	48 hours	$\leq 30^{\circ}C/60\% RH$	72 <sup>1</sup> +5/-0	30 <sup>o</sup> C/60% RH	15 +5/-0	20 +5/-0	60 <sup>o</sup> C/60% RH
5a	24 hours	$\leq 30^{\circ}C/60\% RH$	48 <sup>1</sup> +5/-0	30 <sup>o</sup> C/60% RH	10 +5/-0	13 +5/-0	60 <sup>o</sup> C/60% RH
6	Time on label (TOL)	$\leq 30^{\circ}C/60\% RH$	TOL	30 <sup>o</sup> C/60% RH	NA	NA	NA

### Note:

- The standard soak time includes a default value of 24 hours for semiconductor manufacturer's exposure time (MET) between bake and bag, and includes the maximum time allowed out of the bag at the distributor's facility.

## Optical & Electrical Characteristics

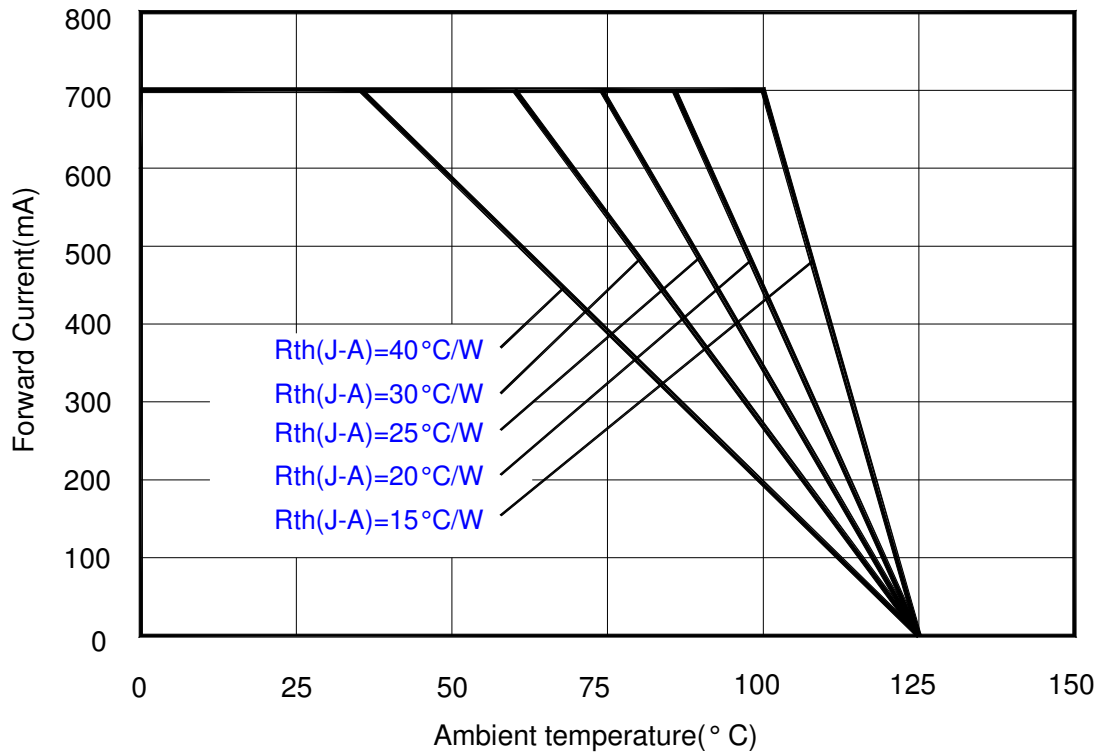

<Figure 10 Forward current & ambient temperature at 700mA>

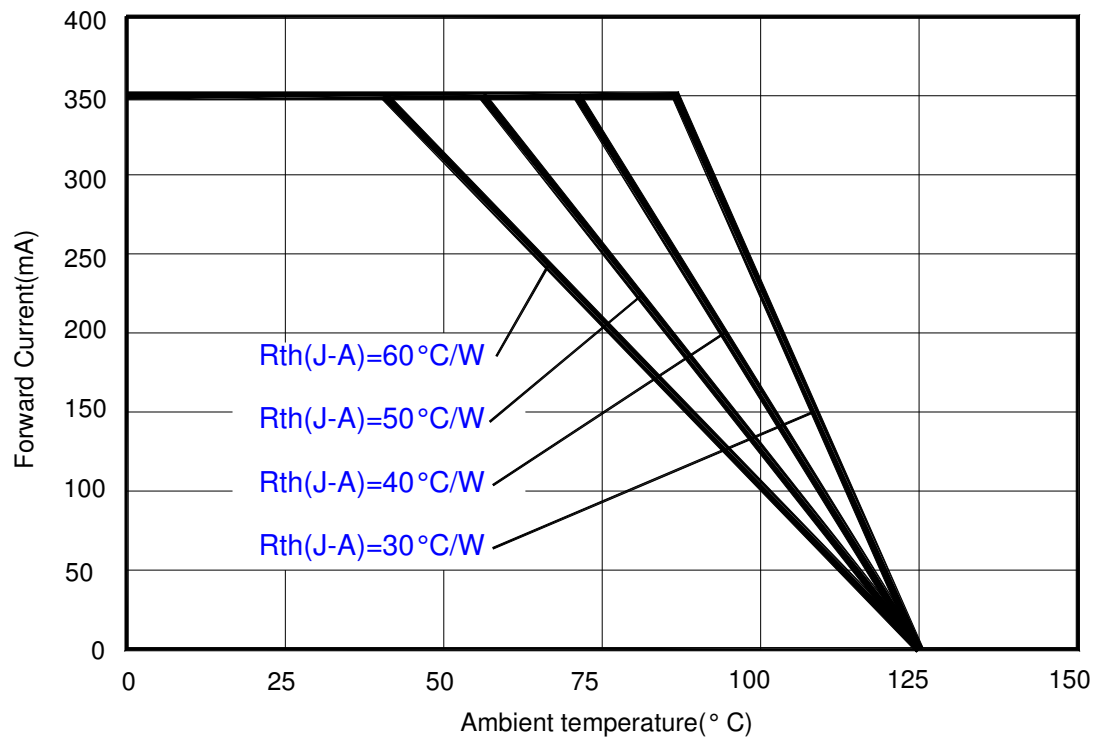

< Figure 11 Forward current & ambient temperature at 350mA >

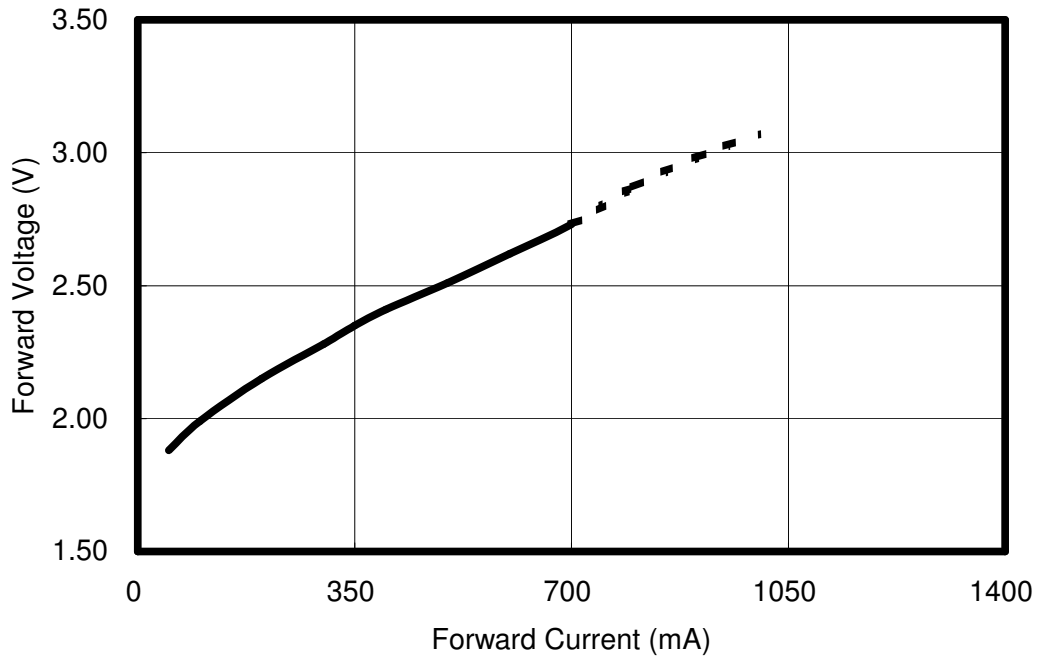

< Figure 12 Forward current & forward voltage for EDER · EDEA at  $T_J=25^{\circ}\text{C}$  >

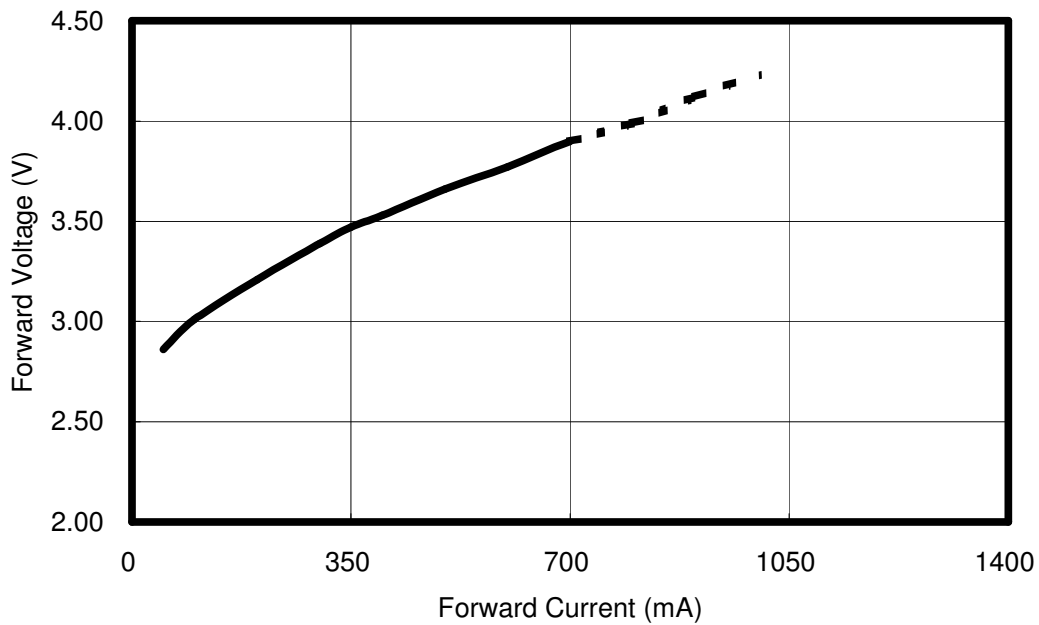

< Figure 13 Forward current & forward voltage for EDET · EDEJ · EDEB · EDEC · EDED · EDEV at  $T_J=25^{\circ}\text{C}$  >

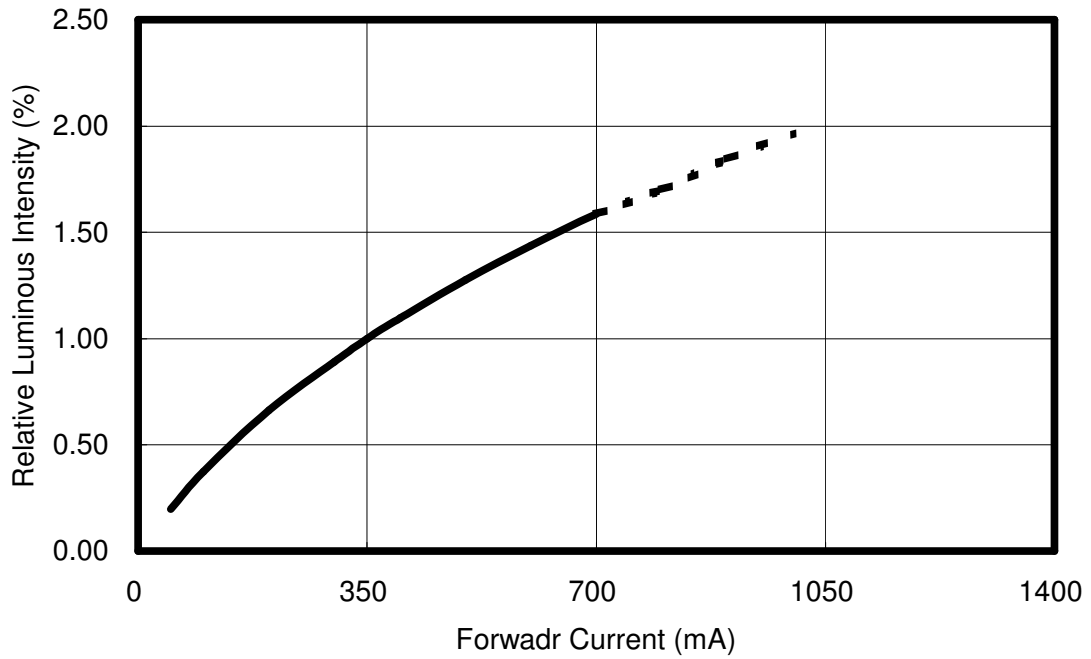

<Figure 14 Forward current & relative luminous for EDER、EDEA at  $T_j=25^{\circ}\text{C}$ >

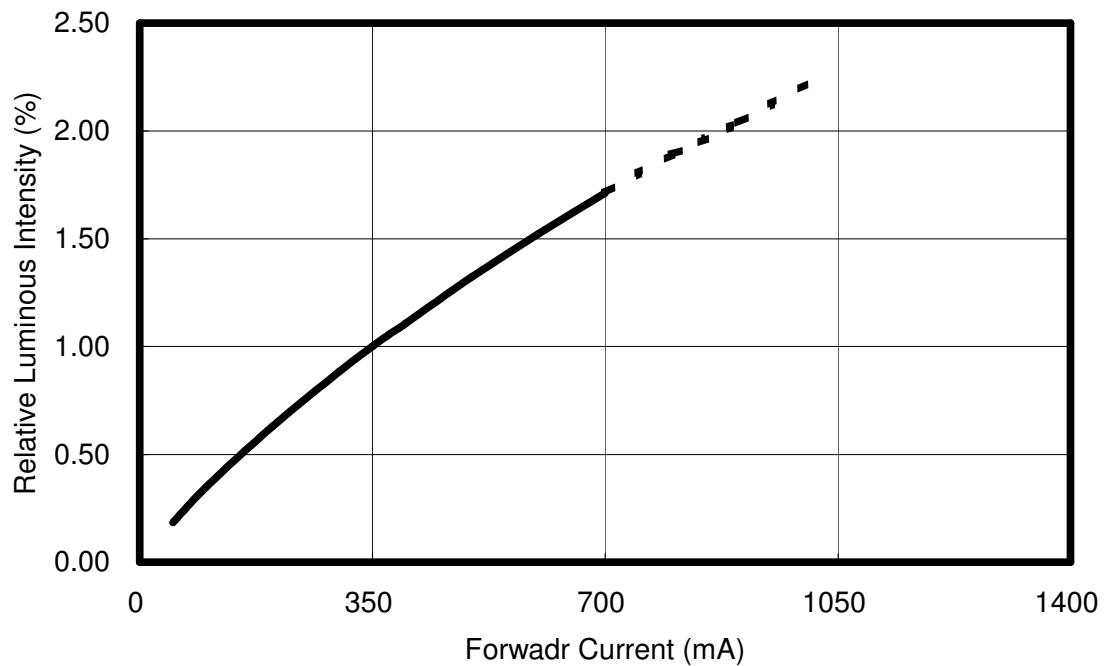

<Figure 15 Forward current & relative luminous for EDET、EDEJ at  $T_j=25^{\circ}\text{C}$ >

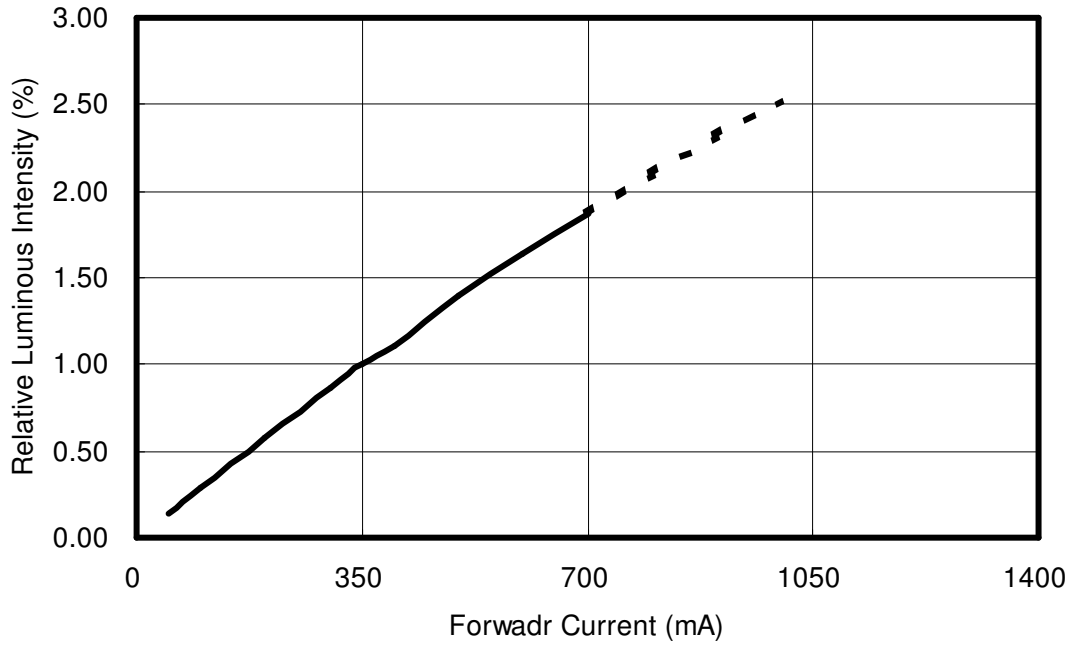

<Figure 16 Forward current & relative luminous for EDEB · EDED · EDEC · EDEV at  $T_j=25^{\circ}\text{C}$ >

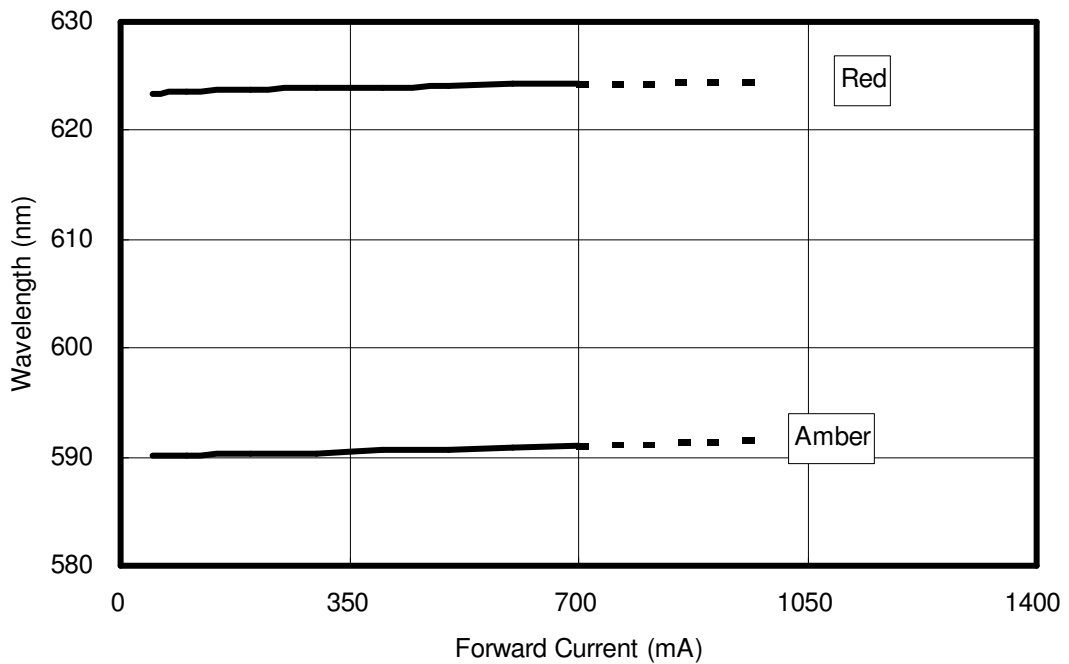

<Figure 17 Forward current & wavelength for EDER · EDEA at  $T_j=25^{\circ}\text{C}$ >

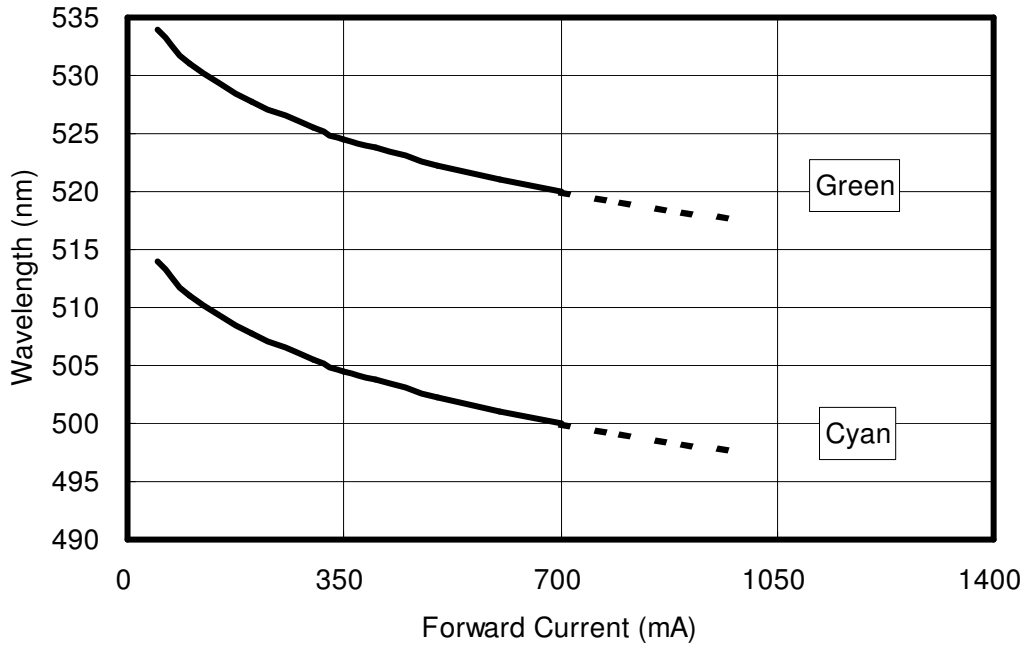

<Figure 18 Forward current & wavelength for EDET、EDEJ at  $T_J=25^{\circ}\text{C}$ >

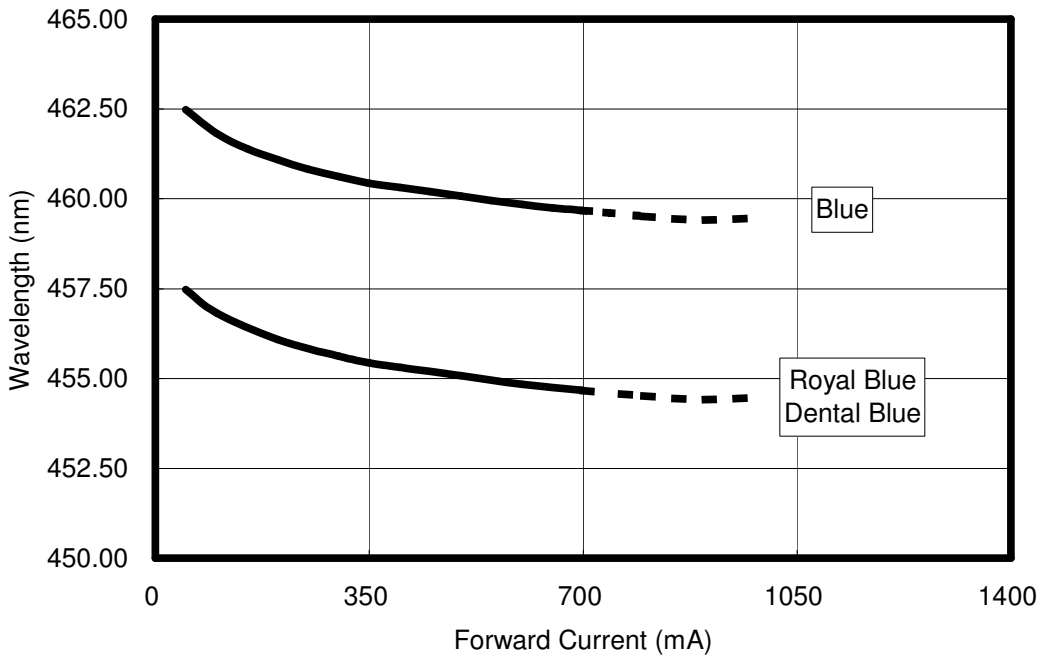

<Figure 19 Forward current & wavelength for EDEB、EDED、EDEC at  $T_J=25^{\circ}\text{C}$ >

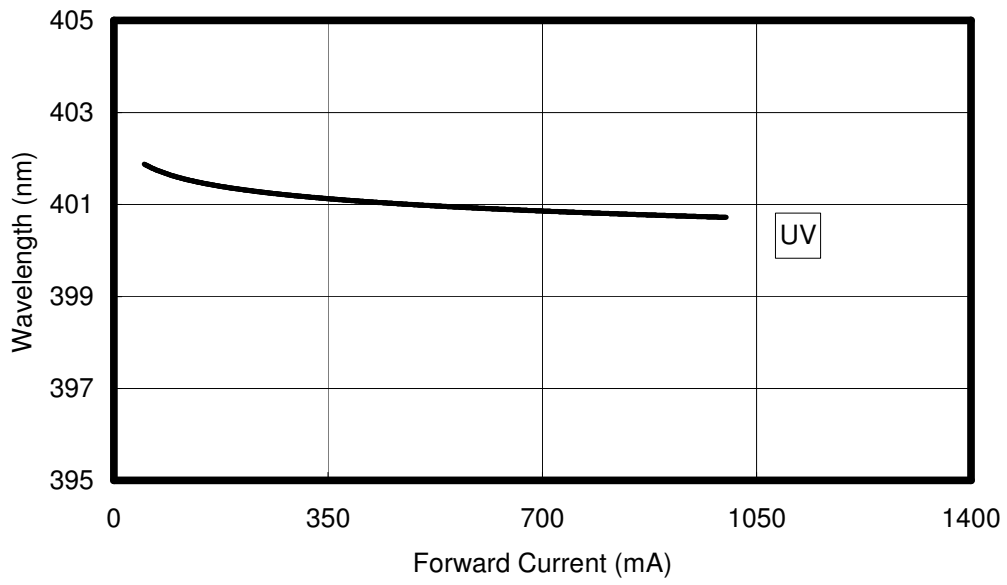

<Figure 20 Forward current & wavelength for EDEV at  $T_J=25^{\circ}\text{C}$ >

## Product Soldering Instructions

The central circle pad at the bottom face of the package provides the main path for heat dissipation from the LED to the heat sink (heatsink contact).

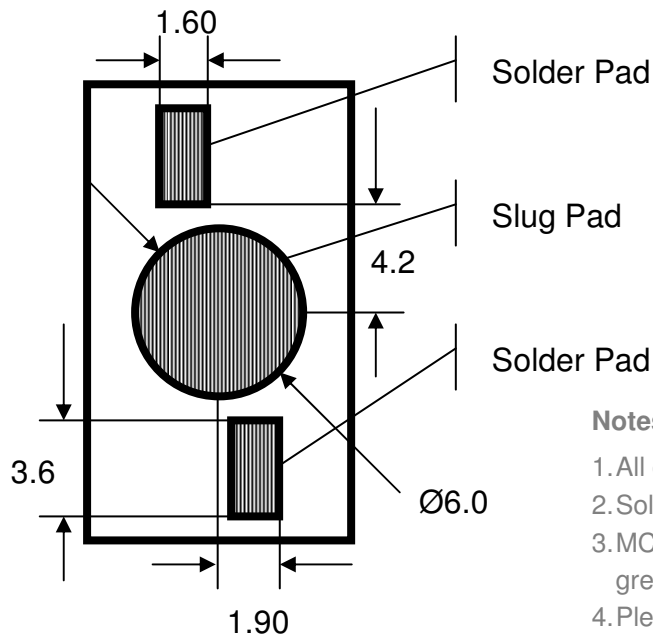

< Figure 21 Pad dimensions >

### Notes:

1. All dimensions are measured in mm.
2. Solder pad cannot be connected to slug pad.
3. MCPCB material with a thermal conductivity greater than 3.0 W/mK.
4. Please avoid touching the Edixeon<sup>®</sup> lens during assembly processes. This may cause pollution or scratch on the surface of lens.

The choice of solder and the application method will dictate the specific amount of solder. For most consistent results, an automated dispensing system or a solder stencil printer is recommended.

Positive results will be used solder thickness that results in 50µm. The lamp can be placed on the PCB simultaneously with any other required SMD devices and reflow completed in a single step. Automated pick-and-place tools are recommended.

The central slug at the bottom face of the package provides the main path for heat dissipation from the LED to the heat sink (heat sink contact). A key feature of Edixeon<sup>®</sup> emitter is an electrically neutral heat path that is separate from the LED's electrical contacts. This electrically isolated thermal pad makes Edixeon<sup>®</sup> emitter perfect for use with metal-core printed circuit boards (MCPCB).



---

### Recommend Solder Steps

To prevent mechanical failure of LEDs in the soldering process, a carefully controlled preheat and post-cooling sequence is necessary. The heating rate in an IR furnace depends on the absorption coefficients of the material surfaces and on the ratio of the component's mass to its irradiated surface. The temperature of parts in an IR furnace, with a mixture of radiation and convection, cannot be determined in advance.

Temperature measurement may be performed by measuring the temperature of a specific component while it is being transported through the furnace. Influencing parameters on the internal temperature of the component are as follows:

- Time and power
- Mass of the component (for Edixeon<sup>®</sup> S series on MCPCB)
- Size of the MCPCB
- Absorption coefficient of the surfaces and MCPCB
- Packing density

Peak temperatures can vary greatly across the MCPCB during IR processes. The variables that contribute to this wide temperature range include the furnace type and the size, mass and relative location of the components on the board. Profiles must be carefully tested to determine the hottest and coolest points on the board. The hottest and coolest points should fall within the recommended temperatures. The profile of the reflow system should be based on design needs, the selected solder system and the solder-paste manufacturer's recommended reflow profile.

### Recommended Profile for Reflow Soldering

The following reflow soldering profiles are provided for reference. It is recommended that users follow the recommended soldering profile provided by the manufacturer of the solder paste used.

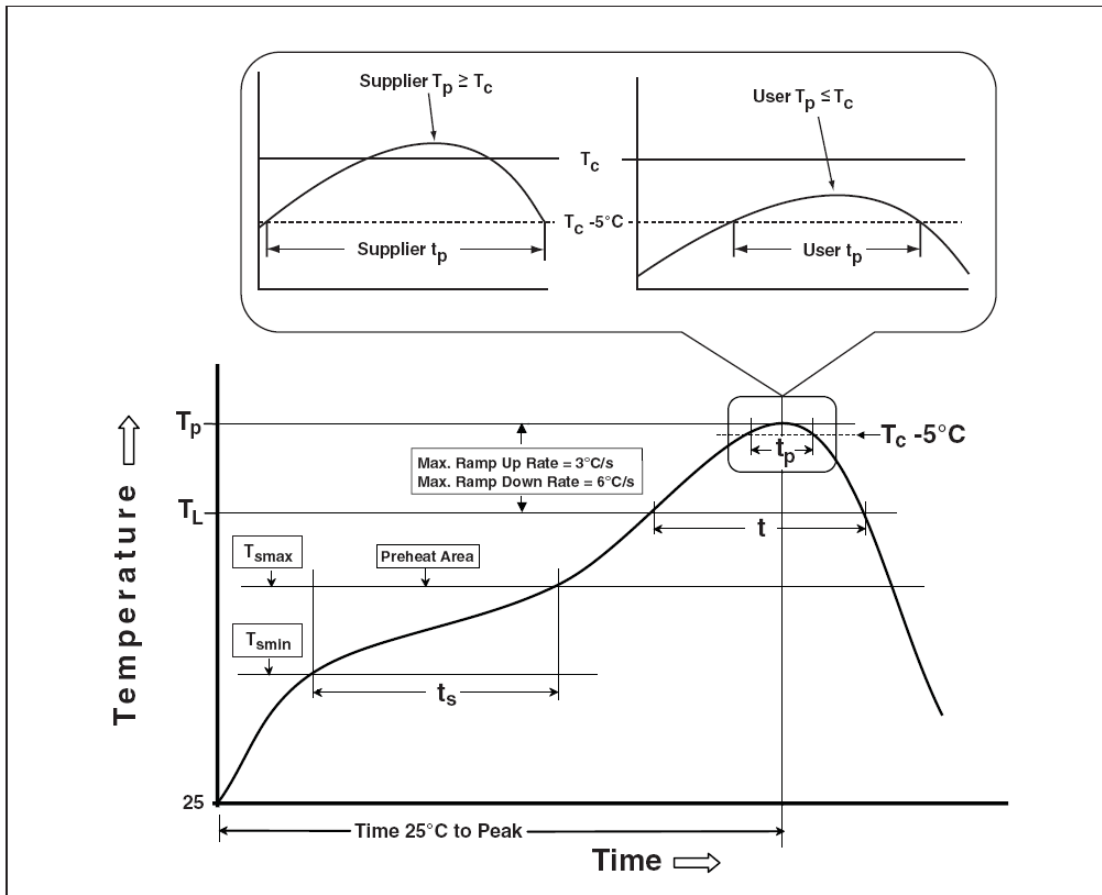

< Figure 22 Reflow profiles >

## Table of Classification Reflow Profiles

< Table 11 Reflow profiles >

Profile Feature	Sn-Pb Eutectic Assembly	Pb-Free Assembly
<b>Preheat &amp; Soak</b> Temperature min (T <sub>min</sub> ) Temperature max (T <sub>max</sub> ) Time (T <sub>min</sub> to T <sub>max</sub> ) (ts)	100 °C 150 °C 60-120 seconds	150 °C 200 °C 60-120 seconds
Average ramp-up rate (T <sub>max</sub> to T <sub>p</sub> )	3 °C/second max.	3 °C/second max.
Liquidous temperature (TL) Time at liquidous (tL)	183 °C 60-150 seconds	217 °C 60-150 seconds
Peak package body temperature (T <sub>p</sub> )*	230 °C ~235 °C *	255 °C ~260 °C *
Classification temperature (T <sub>c</sub> )	235 °C	260 °C
Time (t <sub>p</sub> )** within 5 °C of the specified classification temperature (T <sub>c</sub> )	20** seconds	30** seconds
Average ramp-down rate (T <sub>p</sub> to T <sub>max</sub> )	6 °C/second max.	6 °C/second max.
Time 25 °C to peak temperature	6 minutes max.	8 minutes max.

\* Tolerance for peak profile temperature (T<sub>p</sub>) is defined as a supplier minimum and a user maximum.

\*\* Tolerance for time at peak profile temperature (t<sub>p</sub>) is defined as a supplier minimum and a user maximum.

### Product Thermal Application Information

Thermal grease should be evenly spreaded with a thickness <math>< 100\mu\text{m}</math>.

When assembling on MCPCB or heat sink carrier.

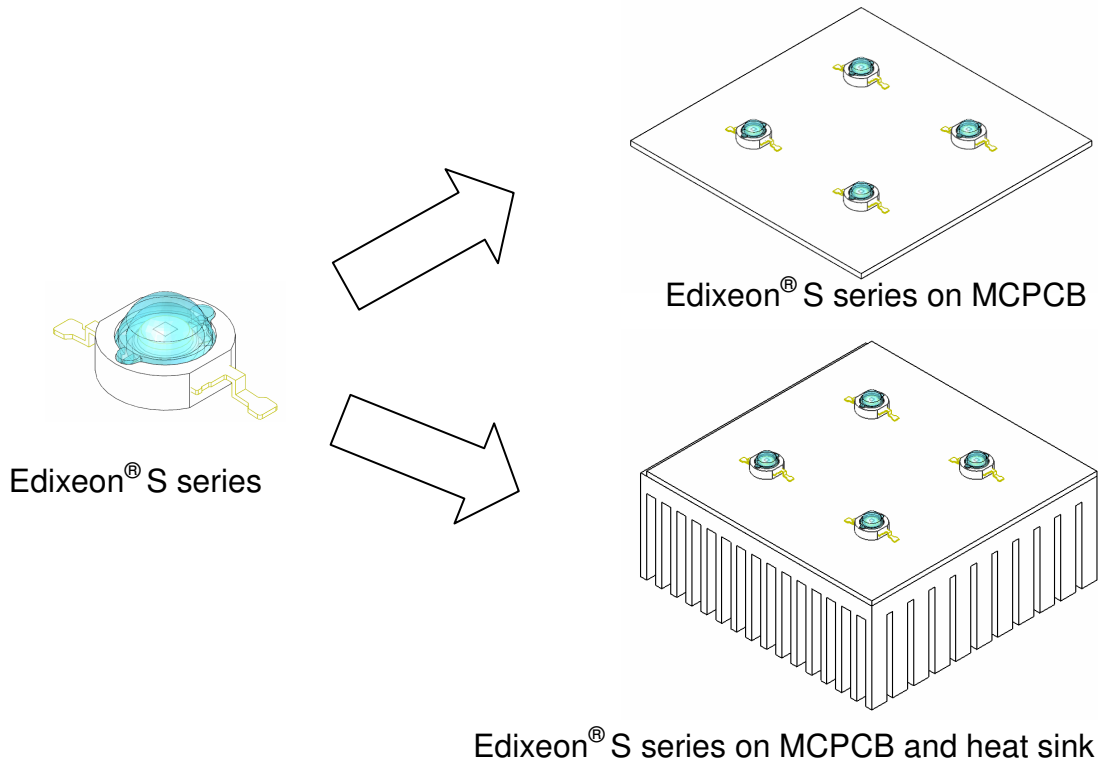

<Figure 23 Edixeon<sup>®</sup> S series heat sink application >

—It is strongly recommended the heat sink should be anodized.

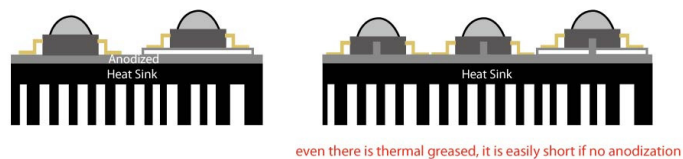

—Please ensure the heat sink is flat enough to prevent the bad heat conductivity.



<Figure 24 Edixeon<sup>®</sup> S series assemble with heatsink>

## Thermal Resistance Application

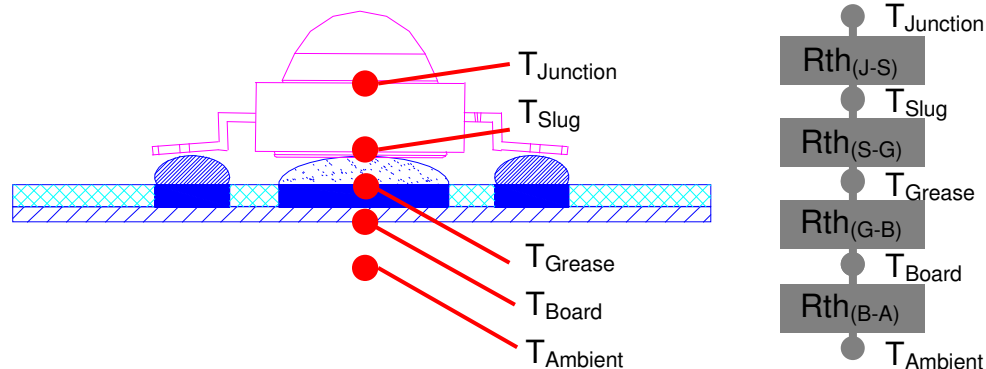

$$R_{th(J-A)} = R_{th(J-S)} + R_{th(S-G)} + R_{th(G-B)} + R_{th(B-A)}$$

$$T_{Junction} = T_{Ambient} + R_{th(J-A)} \times P_{Dissipation}$$

$$(T_J = T_A + R_{th(J-A)} \times P_{Dissipation})$$

<Figure 25 Rth and T<sub>J</sub> for Edixeon® S series >

### Suggested Adhesive for Selection(such as thermal grease)

- Ease of use
  - Non-solvent, One-part
- Fast tack free
  - 3 minutes at 25°C
- No corrosion
  - Alcohol type of room temperature vulcanization (RTV)
- Low volatility
  - Low weight loss of silicone volatiles
- Adhesion
  - Excellent adhesion to most materials without use of a primer
- Dielectric properties
  - Cured rubber exhibits good dielectric properties
- Excellent thermal stability and cold resistance
  - Cured rubber provides wide service temperature range

<Table 12 Specifications for adhesive properties >

Specification	Suggested Properties
Take-free time	3~10 minutes
Specific gravity	< 3 g/cm <sup>2</sup>
Thermal conductivity	> 2.5 W/mK
Rth in using	< 1.8 °C/W
Volume resistance	> 1x10 <sup>14</sup>
Lap shear adhesion strength	> 200 N/ cm <sup>2</sup>
Tensile strength	> 4 Mpa

### Thermal Resistance Calculation

The thermal resistance between two points is defined as the ratio of the difference in temperature to the power dissipated. For calculations in the following units used are °C/W. In the case of LEDs, the resistance of two important thermal paths affects the junction temperature:

From the LED junction to the thermal contact at the bottom of the package, this thermal resistance is governed by the package design. It is referred to as the thermal resistance between junction and slug ( $R_{th (J-S)}$ )

From the thermal contact to ambient conditions, this thermal resistance is defined by the path between the slug ,board ,and ambient. It is referred to as the thermal resistance between slug and board ( $R_{th (S-B)}$ ) and between board and ambient ( $R_{th (B-A)}$ ).

The overall thermal resistance between the LED junction and ambient ( $R_{th (J-A)}$ ) can be modeled as the sum of the series resistances  $R_{th (J-S)}$  ,  $R_{th (S-B)}$  , and  $R_{th (B-A)}$ .

The following will show how to calculate  $R_{th}$  for each part of LED module.

#### 1. $R_{th (J-S)}$

Assume Edixeon®  $R_{th (J-S)}=13\text{ }^{\circ}\text{C/W}$

#### 2. $R_{th (S-G)}$

If the thickness of thermal grease is 100um and area is  $(6.4/2)^2\pi\text{ mm}^2$ .

Thermal conductivity of thermal grease is 2.6 W/mK.

The Formula of  $R_{th}$  is 
$$\frac{\text{Thickness(um)}}{\text{Thermal Conductivity (W/mK) x Area(mm}^2\text{)}}$$

Therefore  $R_{th(S-G)} = \frac{100}{2.6 \times (6.4/2)^2 \pi} = 1.2 \text{ }^\circ\text{C/W}$

### 3. $R_{th(G-B)}$

The  $R_{th}$  of standard MCPCB is  $1.5 \text{ }^\circ\text{C/W}$

### 4. $R_{th(B-A)}$

The  $R_{th}$  between board and air is mainly dependent on the total surface area.

Therefore  $R_{th(B-A)} \doteq \frac{500}{\text{Area}(\text{cm})^2}$

If Area is $30\text{cm}^2$	$R_{th}=16.7$	$R_{th(J-A)} = 13+1.2+1.5+16.7 = 32.4 \text{ }^\circ\text{C/W}$
If Area is $60\text{cm}^2$	$R_{th}=8.3$	$R_{th(J-A)} = 13+1.2+1.5+8.3 = 24 \text{ }^\circ\text{C/W}$
If Area is $90\text{cm}^2$	$R_{th}=5.5$	$R_{th(J-A)} = 13+1.2+1.5+5.5 = 21.2 \text{ }^\circ\text{C/W}$

## Junction Temperature Calculation

The total power dissipated by the LED is the product of the forward voltage ( $V_F$ ) and the forward current ( $I_F$ ) of the LED.

The temperature of the LED junction is the sum of the ambient temperature and the product of the thermal resistance from junction to ambient and the power dissipated.

$$T_{\text{Junction}} = T_{\text{Air}} + R_{th(J-A)} \times P_{\text{Dissipation}}$$

If one white Edixeon<sup>®</sup> in room temperature ( $25^\circ\text{C}$ ) operated  $350\text{mA}$  and  $V_F=3.3\text{V}$ , the  $P_{\text{Dissipation}}=0.35 \times 3.3=1.155\text{W}$

And junction temperature is

$$T_{\text{Junction}} = 25^\circ\text{C} + 21.2 \times 1.155 = 49.486^\circ\text{C} \text{ (total surface area } = 90\text{cm}^2\text{)}$$

$$T_{\text{Junction}} = 25^\circ\text{C} + 24 \times 1.155 = 52.72 \text{ }^\circ\text{C} \text{ (total surface area } = 60\text{cm}^2\text{)}$$

$$T_{\text{Junction}} = 25^\circ\text{C} + 32.4 \times 1.155 = 62.422 \text{ }^\circ\text{C} \text{ (total surface area } = 30\text{cm}^2\text{)}$$

## Example : Junction Temperature Calculation

*One white LED is used under ambient temperature ( $T_{\text{Ambient}}$ ) of  $30^\circ\text{C}$ . This LED is soldered on MCPCB (Area= $10\text{cm}^2$ ). Calculate junction temperature.*

Assuming a forward voltage of  $V_F=3.3\text{V}$  at  $350\text{mA}$  and total power dissipated is

$$P_{\text{Dissipation}} = 1 \times 0.35 \times 3.3 = 1.155 \text{ W.}$$

$$\text{LED } R_{th(J-S)} = 13 \text{ }^\circ\text{C/W.}$$

With good design,  $R_{th(S-G)}$  can be minimized to  $1 \text{ }^\circ\text{C/W}$ .

$R_{th(G-B)}$  of a standard MCPCB can be  $1.5 \text{ }^\circ\text{C/W}$ .

The  $R_{th}$  between board and air is mainly dependent on the total surface area.

Therefore it can be calculated in formula  $\frac{500}{\text{Area}(\text{cm})^2}$

$$R_{th(B-A)} = \frac{500}{10} = 50 \text{ } ^\circ\text{C/W}.$$

Following the formula  $T_{\text{Junction}} = T_{\text{Ambient}} + R_{th(J-A)} \times P_{\text{Dissipation}}$

$$\begin{aligned} T_{\text{Junction}} &= 30 \text{ } ^\circ\text{C} + (13 \text{ } ^\circ\text{C/W} + 1 \text{ } ^\circ\text{C/W} + 1.5 \text{ } ^\circ\text{C/W} + 50 \text{ } ^\circ\text{C/W}) \times 1.155\text{W} \\ &= 105.6525 \text{ } ^\circ\text{C} \end{aligned}$$

That means this LED emitter is operated under good condition ( $T_{\text{Junction}} < 125 \text{ } ^\circ\text{C}$ ).

It's strongly recommended to keep the junction temperature under  $125 \text{ } ^\circ\text{C}$

Or keep the temperature of emitter lead not exceed  $55 \text{ } ^\circ\text{C}$



## Product Electrical Application Information

Following graphs and descriptions show how to connect LED or LED module and plug to AC outlet.

Step1: Connect the wires of LED Module to the DC output of the driver.

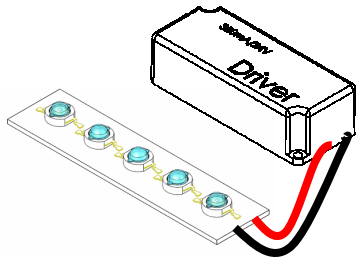

<Figure 26 LED Module connect to the DC output of the driver>

Step2 : Plug the driver to AC outlet.

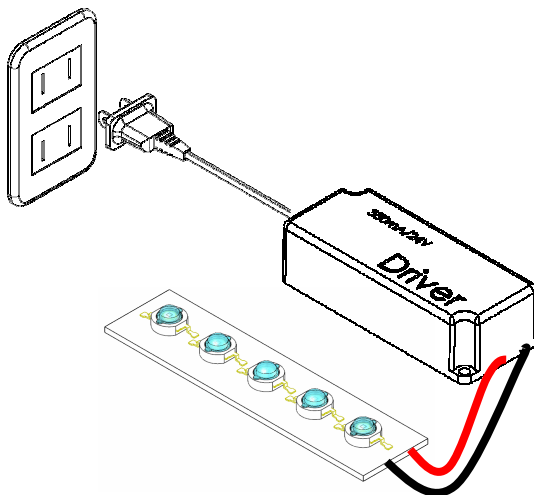

<Figure 27 Plug the AC output of the driver to AC outlet>

Caution: Never plug the driver to AC outlet before the LED Module is properly connected as this may generate transient voltage damage the LEDs permanently with a short or open circuit.

### Emitter Product Packaging Information

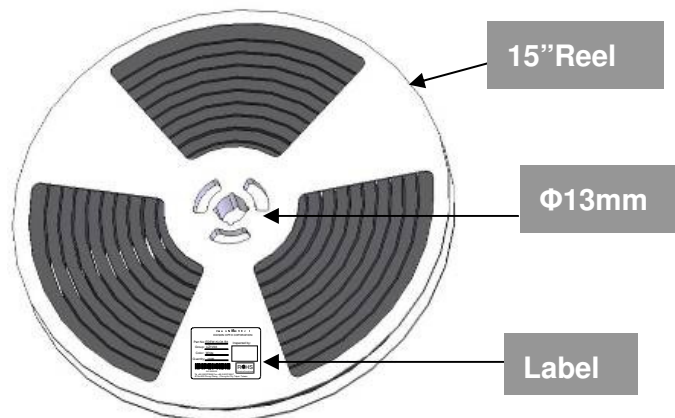
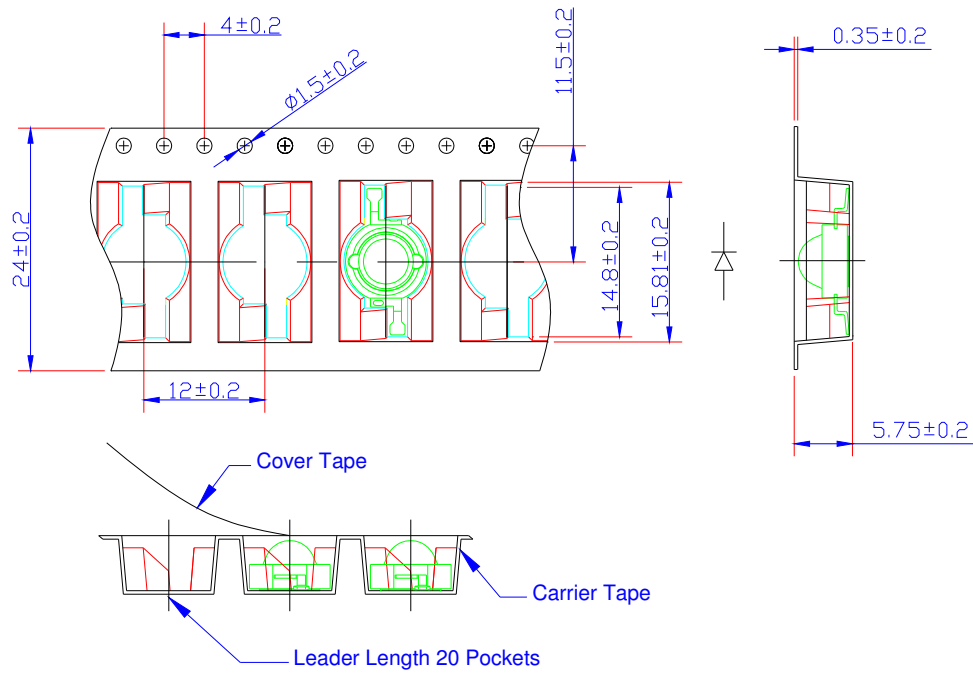

Item	Quantity	Total	Dimensions(mm)
15"Reel	1,000pcs	1,000pcs	Diameter=380
Inner box	2 reels	2,000pcs	390*390*170
Outer box	2 inner boxes	4,000pcs	425*405*350

<Figure 28 Taping reel dimensions>

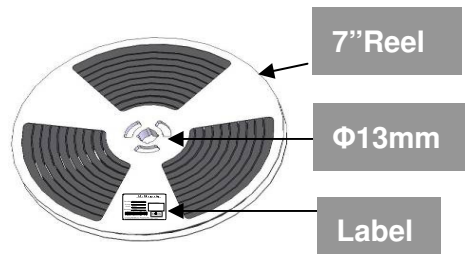

Item	Quantity	Total	Dimensions(mm)
7" Reel	200pcs	200pcs	Diameter=178
Inner box	2 reels	400pcs	240*235*67
Outer box	5 inner boxes	2,000pcs	353*254*256

<Figure 29 Taping reel dimensions>

The Label

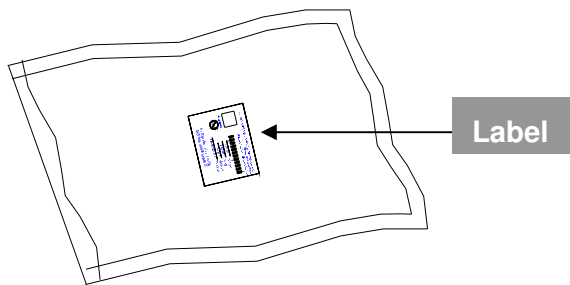

< Figure 30 Label on bag >



< Figure 31 Package label >

## Star Product Packaging Information

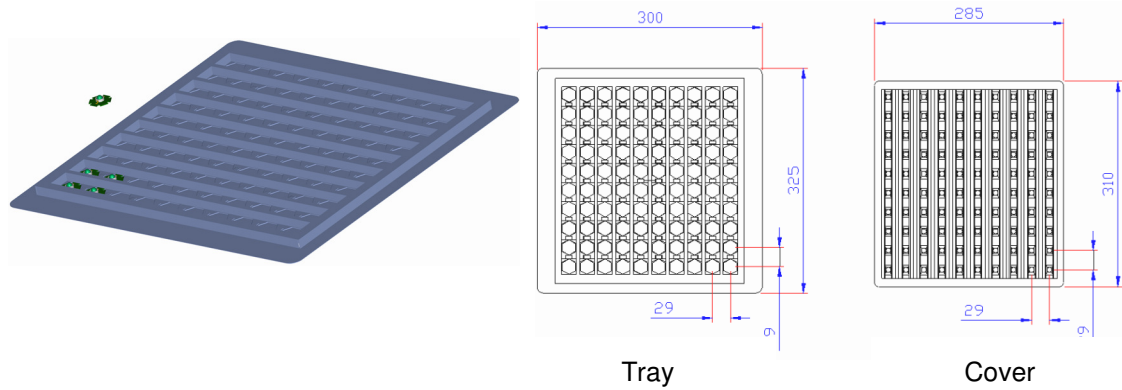

Item	Quantity	Total	Dimensions(mm)
Tray	100pcs	100pcs	325*300
Inner box	10 Tray	1,000pcs	340*330*160
Outer box	2 inner boxes	2,000pcs	350*350*340

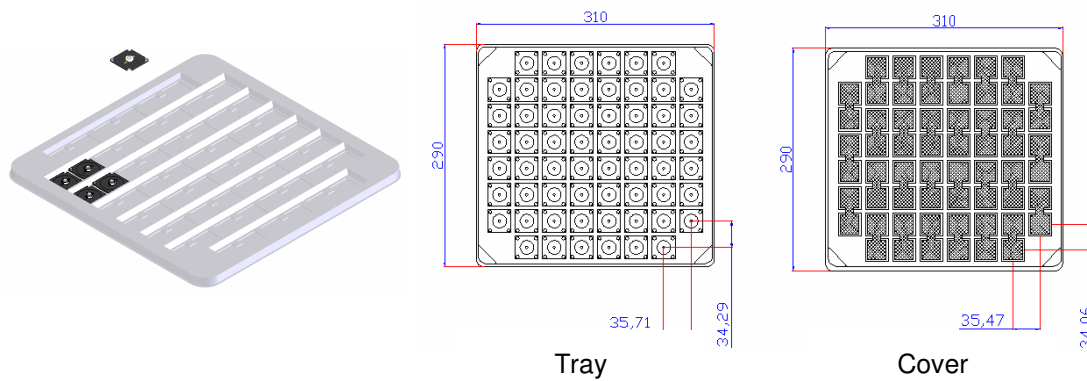

Item	Quantity	Total	Dimensions(mm)
Tray	60pcs	60pcs	310*290
Inner box	10 Tray	600pcs	340*330*160
Outer box	2 inner boxes	1200pcs	350*350*340

<Figure 32 Edixeon® Star Package>